

# Notes on 1 Kings

2015 Edition

**Dr. Thomas L. Constable**

## Introduction

### TITLE

The Books of 1 and 2 Kings received their names because they document the reigns of the 40 monarchs of the kingdoms of Israel and Judah following David. Israel had 20 kings, and Judah had 20, including one female who usurped the throne: Athaliah.

In the Hebrew Bible, 1 and 2 Kings were one book until the sixteenth century. The ancients regarded them as the continuation of the narrative begun in Samuel. The Septuagint (Greek) translation of the Hebrew text, dating from about 250 B.C., was the first to divide Kings into two books. That division has continued to the present day. The Septuagint translators, however, called these two books 3 and 4 Kingdoms (or Reigns). First and 2 Kingdoms (or Reigns) were our 1 and 2 Samuel. Jerome's Vulgate (Latin) translation, which dates to about A.D. 400, changed the name from Kingdoms to Kings.

"The English Bible presents the books primarily as historical accounts. Their placement next to 1, 2 Chronicles demonstrates the collectors' interest in detailing all the events of Israel's history. In contrast, the Hebrew Bible places Joshua-Kings with the prophets, which highlights their common viewpoints. This decision implies that 1, 2 Kings are being treated as proclamation *and* history."<sup>1</sup>

First and 2 Kings are the last of the Former Prophets books in the Hebrew Bible. The others are Joshua, Judges, and Samuel.

### WRITER AND DATE

Most Old Testament scholars today believe several different individuals wrote and edited Kings because of theories concerning textual transmission that have gained popularity in the last 150 years.<sup>2</sup> However, many conservatives have continued to follow the older tradition of the church that one individual probably put Kings together.<sup>3</sup> This view finds support in the stylistic and linguistic features that run through the whole work and make

---

<sup>1</sup>Paul R. House, *1, 2 Kings*, p. 70.

<sup>2</sup>For discussion, see Tremper Longman III and Raymond B. Dillard, *An Introduction to the Old Testament*, pp. 171-75.

<sup>3</sup>E.g., D. J. Wiseman, *1 & 2 Kings: An Introduction and Commentary*, pp. 16, 53.

it read like the product of a single writer. Some of these features are the way the writer described and summarized each king's reign, the consistent basis on which he evaluated all the kings, and recurring phrases and terms. Paul House believed the same writer composed Joshua, Judges, Samuel, and Kings.<sup>4</sup> The father of the Deuteronomistic theory of authorship, Martin Noth, believed in single authorship but in an author who lived in the mid-sixth century B.C.<sup>5</sup> The Deuteronomistic (or Deuteronomic) theory is that the writer of Kings, as well as the writers of Joshua, Judges, and Samuel, wrote using Deuteronomy as the standard by which they evaluated what Israel and its leaders did during the years those books record.<sup>6</sup> Even though many advocates of this view were and are liberal in their theology, the text supports the basic thesis of this theory.<sup>7</sup>

The identity of the writer is unknown today and has been for centuries. Ancient Jewish tradition suggested Ezra or Ezekiel as possible writers since both of these men were inspired writers who lived after the Babylonian exile. The record of King Jehoiachin's release from Babylonian captivity (2 Kings 25:27-30) points to a date of final composition sometime after that event. Jeremiah has traditional Babylonian Talmudic support as well, though Jeremiah apparently never went to Babylon but died in Egypt.<sup>8</sup> Someone else could have written the last few verses of the book (i.e., 2 Kings 25:27-30), or, perhaps, all of Kings. Scholars have suggested these famous men because they were known writers who lived after the destruction of Jerusalem.

Most non-conservatives date Kings considerably later than the sixth or fifth centuries.<sup>9</sup>

### **SCOPE**

The historical period Kings covers totals about 413 years. The events that frame this period were Solomon's coronation as co-regent with David (973 B.C.) and Jehoiachin's release from Babylonian exile (561 B.C.).

However, most of Kings deals with the period that spans Solomon's coronation and the destruction of Jerusalem in 586 B.C., a period of 387 years. At the beginning we see the temple built and at the end the temple burnt.

". . . 1, 2 Kings present Israel's history as a series of events that describe how and why the nation fell from the heights of national prosperity to the depths of conquest and exile."<sup>10</sup>

"More specifically, 1, 2 Kings explain how and why Israel lost the land it fought so hard to win in Joshua and worked so hard to organize in Judges and 1, 2 Samuel."<sup>11</sup>

---

<sup>4</sup>House, pp. 38-39.

<sup>5</sup>Martin Noth, *The Deuteronomistic History*, pp. 75-78.

<sup>6</sup>See Longman and Dillard, pp. 182-86, for support.

<sup>7</sup>See David M. Howard Jr., *An Introduction to the Old Testament Historical Books*, pp. 179-82.

<sup>8</sup>*Baba Bathra* 15a.

<sup>9</sup>For further discussion of their theories, see Gleason Archer Jr., *A Survey of Old Testament Introduction*, pp. 289-91, and other Old Testament Introductions.

<sup>10</sup>House, p. 15.

<sup>11</sup>*Ibid.*, p. 28.

"Plot relates the causes and effects in a story. Thus, the story line in 1, 2 Kings may be that Israel went into exile, but the plot is Israel went into exile because of its unfaithfulness to God. To make cause and effect unfold, plots normally have at least two basic aspects: conflict and resolution. A plot's conflict is the tension in a story that makes it an interesting account, while a plot's resolution is the way the conflict is settled. How the author develops these two components usually decides the shape and effectiveness of the plot."<sup>12</sup>

This historical period is more than twice that of the one the Books of Samuel covered, which was about 150 years in length. The Book of Judges covers about 300 years of Israel's history.

The dates of the kings of Israel and Judah that I have used in these notes are those of Edwin Thiele.<sup>13</sup> Thiele clarified that Judah and Israel counted the beginning of reigns differently. Normally Judah began counting a king's reign with the first of the calendar year in which his accession to the throne fell. Israel reckoned its kings' reigns from the time those reigns actually began. However, during one period both kingdoms used the same system.<sup>14</sup> A further complication was that these kingdoms began their calendar years six months apart.<sup>15</sup> Another phenomenon was co-regencies, in which the reigns of two or more kings of the same kingdom overlapped. Thiele worked out the many problems regarding these dates more satisfactorily than anyone else in the opinion of many scholars.<sup>16</sup> Chronology is more important in 1 and 2 Kings than in any other books of the Bible.<sup>17</sup>

### **PURPOSE**

The Holy Spirit led the writer of Kings to give an interpretation of history, not just a chronologically sequential record of events, as is true of all the writers of the Old Testament historical books. Some of the events in Kings are not in chronological order. They appear in the text as they do usually to make a point that was primarily theologically edifying (i.e., to reveal a spiritual lesson from history). The writer chose the historical data he included for this purpose under the superintending inspiration of the Holy Spirit (2 Tim. 3:16; 2 Pet. 1:21). The major lesson that Kings teaches its readers is that failure to honor the revealed will of God results in ruin and destruction.<sup>18</sup> For Israel the revealed will of God was the Mosaic Law and the later revelations of the prophets (men and women who spoke for God).

---

<sup>12</sup>Ibid., pp. 61-62.

<sup>13</sup>Edwin R. Thiele, *The Mysterious Numbers of the Hebrew Kings*. See Appendix 1 at the end of these notes for a chart of the "Dates of the Rulers of Judah and Israel."

<sup>14</sup>Ibid., pp. 21, 44.

<sup>15</sup>Ibid., p. 45.

<sup>16</sup>See *ibid.*, p. 27. For an update of Thiele's work, see Leslie McFall, "A Translation Guide to the Chronological Data in Kings and Chronicles," *Bibliotheca Sacra* 148:589 (January-March 1991):3-45. Another revision of Thiele's dates is in Wiseman, pp. 28-29.

<sup>17</sup>Howard, p. 182.

<sup>18</sup>John Gray, *I & II Kings*, pp. 4-5.

"The lesson for God's people during the period of the Exile in Babylonia and afterward—which is the time period addressed by the author of these books—is threefold: (1) that Israel should learn a lesson from the mistakes of its forebears [*sic*] and listen to God's mouthpieces, the prophets, in order to avoid such severe punishment again; but (2) that God nevertheless is a good and gracious God, still ready to forgive when people truly repent; and (3) that He still holds out hope for His people, regardless of how dire their circumstances."<sup>19</sup>

### **GENRE**

Kings continues in the theological history genre that marks all of the historical books of the Old Testament.

### **STYLE**

"By way of contrast with the other two books covering the historical details of the united and divided kingdoms, one might say that whereas Samuel's author uses a biographical style and Chronicles is written from a theological standpoint, the author of Kings employs a largely narrative-annalistic approach."<sup>20</sup>

The writer of Kings organized his material around the reigns of the kings of Israel and Judah, beginning with David and ending with Zedekiah, the last king of Judah. Following the division of the kingdom after Solomon's death, the writer constructed a framework to enclose what he wrote about each king's reign. This framework begins with a standardized notice of the king's accession, and it ends with an equally standardized notice of the king's death, though there is some variety in these notices. The accession notice typically includes the following information: synchronization with the contemporary king or kings of the other Israelite kingdom (until Hoshea), the king's age at his accession (Judah only), and the length of his reign. It also includes his capital city, the name of the queen mother (Judah only), and the writer's theological assessment of the king. The death notice normally contains information about other sources of information about the king, notice of the king's death and burial, and identification of his successor.<sup>21</sup>

### **THEOLOGY**

All three major sections of Kings emphasize many theological lessons, but each one repeats and reinforces the main motif: the importance of obeying the Mosaic Law in order to succeed. This motif stands out very clearly in the first major section dealing with Solomon's reign (chs. 1—11). The nation of Israel reached the height of its power and prestige in Solomon's day. It began to decline because of Solomon's unfaithfulness and failure to honor the Mosaic Covenant. Other important theological emphases in Kings

---

<sup>19</sup>Howard, p. 169.

<sup>20</sup>R. D. Patterson and Herman J. Austel, "1, 2 Kings," in *1 Kings-Job*, vol. 4 of *The Expositor's Bible Commentary*, p. 8.

<sup>21</sup>See Longman and Dillard, pp. 176-79, for further discussion of the chronological notices in these books.

include the sovereignty of God, the kingdom of God, the Davidic kingdom, God's grace, hope for the future, judgment, and repentance.<sup>22</sup>

### OUTLINE

- I. The reign of Solomon chs. 1—11
  - A. Solomon's succession to David's throne 1:1—2:12
    - 1. David's declining health 1:1-4
    - 2. Adonijah's attempt to seize the throne 1:5-53
    - 3. David's charge to Solomon 2:1-9
    - 4. David's death 2:10-12
  - B. The foundation of Solomon's reign 2:13—4:34
    - 1. Solomon's purges 2:13-46
    - 2. Solomon's wisdom from God ch. 3
    - 3. Solomon's political strength ch. 4
  - C. Solomon's greatest contribution chs. 5—8
    - 1. Preparations for building ch. 5
    - 2. Temple construction ch. 6
    - 3. Solomon's palace 7:1-12
    - 4. The temple furnishings 7:13-51
    - 5. The temple dedication ch. 8
  - D. The fruits of Solomon's reign chs. 9—11
    - 1. God's covenant with Solomon 9:1-9
    - 2. Further evidences of God's blessing 9:10-28
    - 3. Solomon's greatness ch. 10
    - 4. Solomon's apostasy ch. 11
- II. The divided kingdom 1 Kings 12—2 Kings 17
  - A. The first period of antagonism 12:1—16:28
    - 1. The division of the kingdom 12:1-24
    - 2. Jeroboam's evil reign in Israel 12:25—14:20
    - 3. Rehoboam's evil reign in Judah 14:21-31
    - 4. Abijam's evil reign in Judah 15:1-8
    - 5. Asa's good reign in Judah 15:9-24
    - 6. Nadab's evil reign in Israel 15:25-32
    - 7. Baasha's evil reign in Israel 15:33—16:7
    - 8. Elah's evil reign in Israel 16:8-14
    - 9. Zimri's evil reign in Israel 16:15-20
    - 10. Omri's evil reign in Israel 16:21-28

---

<sup>22</sup>For further discussion of some of these themes, see Howard, pp. 197-203.

- B. The period of alliance 1 Kings 16:29—2 Kings 9:29
1. Ahab's evil reign in Israel 16:29—22:40
  2. Jehoshaphat's good reign in Judah 22:41-50
  3. Ahaziah's evil reign in Israel 1 Kings 22:51—2 Kings 1:18

(Continued in notes on 2 Kings)

One writer observed that a chiasmic structure marks the Books of Kings.<sup>23</sup>

- A** Solomon/United Monarchy — 1 Kings 1:1—11:25
- B** Jeroboam/Rehoboam; the division of the kingdom — 1 Kings 11:26—14:31
- C** Kings of Judah/Israel — 1 Kings 15:1—16:22
- D** The Omride dynasty; the rise and fall of the Baal cult in Israel and Judah — 1 Kings 16:23—2 Kings 12
- C'** Kings of Judah/Israel — 2 Kings 13—16
- B'** The fall of the Northern Kingdom — 2 Kings 17
- A'** The Kingdom of Judah — 2 Kings 18—25.

### MESSAGE

The fact that this book opens and closes with death should be a clue to its message. It opens with David's death, and it closes with Ahab's death. The intervening period of about a century and a half is a story of national decline, disruption, disintegration, and disaster. Israel and Judah passed from affluence and influence to poverty and paralysis.

"In the final analysis, First Kings is the story of one people headed down two different paths. It is a story of good kings and bad kings, true prophets and false prophets, and of disobedience and loyalty to God. Most importantly, it is a story of Israel's spiritual odyssey and God's faithfulness to His people."<sup>24</sup>

There is also an emphasis in this book on *thrones*.

Obviously there were the thrones of Judah and Israel on earth with their kings, who succeeded one another. However, there is also the throne in heaven with its one King. Rehoboam and Jeroboam had their successors: the kings who replaced one another. Yahweh also, in a sense, had His successors: the prophets who replaced one another as His messengers to the people. While the kings remind us of the thrones on earth, the prophets remind us of the throne in heaven. The chief character in the first part of the book is King Solomon. The chief characters in the second part of the book are the prophets Elijah and Elisha.

<sup>23</sup>George Savran, "1 and 2 Kings," in *The Literary Guide to the Bible*, p. 148.

<sup>24</sup>*The Nelson Study Bible*, p. 556.

The thrones on earth present a story of disruption, disintegration, and disaster in both kingdoms, Judah and Israel. This trend continued despite changes in the methods the various rulers employed to govern their people.

Solomon's method of governing was oppression. He taxed the people greatly and conscripted them into government service. The result was material magnificence. He multiplied riches and manifested great displays in the temple, the palace, and throughout his kingdom. He increased the military strength of the nation. Nevertheless, in the process, he ground down the people. He kept them under his thumb. The state became more important than the people. The testimony to this appears in 12:4. The result was dissatisfaction with Solomon's method of government.

In reaction to this method, Rehoboam, in the south, chose a new method of government: autocracy. He decided to tighten his grip on the people so that he could control them (12:14). He believed the people should trust in their rulers, but he did not trust in God. Consequently, he failed. Autocracy led to revolution (12:16).

Jeroboam, in the north, chose a third method of government: democracy. He let the people determine how they would live. While this resulted in more pleasant conditions for the people, it also resulted in ultimate disaster for his nation. Notice what democracy produced in Jeroboam's day: idolatry (12:27-29). People cannot rule themselves effectively. We need God to govern us. Jeroboam believed rulers should trust in the people, but he, like Rehoboam, did not trust in God, either. Consequently, he failed. He made religion convenient, and the people became corrupt (12:30-31).

Rehoboam's successors in Judah chose a method of government that we could call government by policy. That is, they chose to follow precedent, the pattern of their predecessors, rather than getting and following God's direction for their nation. There were some exceptions to this approach, but on the whole this was Judah's method of government.

Jeroboam's successors in Israel, however, chose a different method of government: selfishness. The kings of Israel cared little for the people of Israel. What concerned them primarily was what they could get for themselves out of being king. That is why the story of the kingdom of Israel is a story of intrigue, assassinations, and much bloodshed.

In summary, every form of human government results in disastrous failure if people do not acknowledge God's sovereignty. People cannot govern themselves effectively. The result is always decline, disruption, and disintegration. This is one of the great revelations of 1 Kings.

However, there is another throne in view in this book: the throne in heaven. Whereas 1 Kings reveals that human government always fails, it also reveals that God's government never fails. There are two ways that God exercised His kingship over His people during Israel's monarchy.

First, He broke in on human life with messages that the prophets delivered. Ahijah announced the division of the kingdom (11:26-39). Later, he announced the death of Jeroboam's son (14:4-16). Shemaiah directed Rehoboam not to fight against Jeroboam (12:21-24). An unnamed prophet announced the fate of Jeroboam's altar (13:1-10). Jehu announced Baasha's doom (16:1-4). Elijah vindicated Yahweh in the days of Ahab's apostasy (chs. 17—21). Another unnamed prophet rebuked Ahab for allowing Ben-Hadad to escape (20:35-43). Micaiah foretold Israel's scattering (22:8-28).<sup>25</sup> These are all evidences that God was governing His people independently of the kings when they forgot Him. The heavenly throne ruled in spite of the earthly thrones.

The second way God exercised His rule, in addition to sending messages by the prophets, was by directly and indirectly intervening in the lives of His people. He appeared and spoke directly to Solomon, which resulted in the building of the temple. He raised up an adversary to Solomon, namely: Jeroboam. He assassinated Abijah. He withheld rain and brought famine. He sent fire from heaven on Mt. Carmel. He sent rain. He appeared to Elijah in an earthquake. He enticed Ahab into battle through the mouths of lying prophets.

In short, God ruled by exercising influence over people, by directly intervening and by controlling circumstances occasionally. He manipulated history. God sits in perfect control and continuity over all the human chaos caused by peoples' failure to rule themselves.

The message of the book, therefore, is that when people exclude God, every method of human government will fail. Nonetheless, God is still on His throne and is in control.

If people exclude God, every method of government ends in disaster. Even though in Solomon's reign the king emphasized religious forms and ceremonies, internal development, foreign treaties, and intellectual attainment, his oppression did not bring stability and peace. Autocracy will end in revolution eventually. Democracy that locks God out can result in the most terrible consequences for the people whose interests it professes to advocate. Government by policy can only deteriorate. Selfish rulers will only rape their nations.

Man cannot govern himself because he does not know himself, apart from God's Word. How can he govern others about whom he knows even less? If people do not submit to the throne in heaven, no matter what method of government they choose, they will fail. As Christians, we must remember who is in control. We must look beyond our government to our God.

First Kings also reveals God's method in the midst of human failures.

First, when a throne on earth rebels against the throne in heaven, God abandons that throne on earth. He separated Himself from it. He allowed the evil choices of the rulers to

---

<sup>25</sup>For a chart of the faithful prophets who ministered during the Divided Kingdom Period, see Appendix 2 at the end of these notes.



work themselves out to their inevitable consequences. Departure leads to disaster. Apostasy results in awful consequences (cf. Rom. 1).

Second, God keeps some consciousness of Himself and His government alive in the hearts and minds of a remnant. Even in Elijah's day, there were 7,000 who did not bow the knee to Baal. And the prophets spoke. All Christians exercise that ministry today. We should speak for God to our generation.

Third, God maintains ultimate control. He controls history both directly and indirectly, so His purposes *do* get accomplished. The Christian never needs to panic. God has revealed His plan for history. Knowledge of the Word should give us stability in uncertain times.

What is true on the national scale is also true on the individual level. If a person excludes God from his or her life, no matter how the person may live, he or she will fail, from God's perspective. We can resist God's authority, but we cannot overcome it. People only break themselves by refusing to submit to the throne in heaven. People need reminding of the throne in heaven. These principles have worked out throughout history. God's plan moves ahead.<sup>26</sup>

---

<sup>26</sup>Adapted from G. Campbell Morgan, *Living Messages of the Books of the Bible*, 1:1:177-90.

## Exposition

### I. THE REIGN OF SOLOMON CHS. 1—11

The structure of the record of Solomon's reign is as follows. Chapters 1—2 and 11:14-43 draw a frame around the whole history of Solomon's rule. Within this frame two similar sections form the body of the revelation. The first (3:1—8:66) is favorable to Solomon and the second (9:1—11:13) is critical of him. This is the same historiographic pattern that the writer of Samuel used in describing the reigns of Saul and David. Each of these sections begins with a dream (3:1-15; 9:1-10a), and each ends with a revelation of Solomon's attitude toward God (chs. 6—8; 11:1-13). The first section has two parts. Part one reveals Solomon's domestic policy with sub-sections on women and wisdom (3:16-28), and administration and wisdom (4:1—5:14). Part two deals with Solomon's labor relations and has sub-sections on the contract with Hiram (5:15-27) and the corvée (5:28-33). The second section also has two parts. Part one gives more information about Solomon's labor relations and has sub-sections on the contract with Hiram (9:10b-14) and the corvée (9:15-28). Part two explains Solomon's foreign policy with sub-sections on women and wisdom (10:1-13), and wealth and wisdom (10:14-29). Thus there is both a chiasmic and an unfolding structure in chapters 1—11.<sup>27</sup>

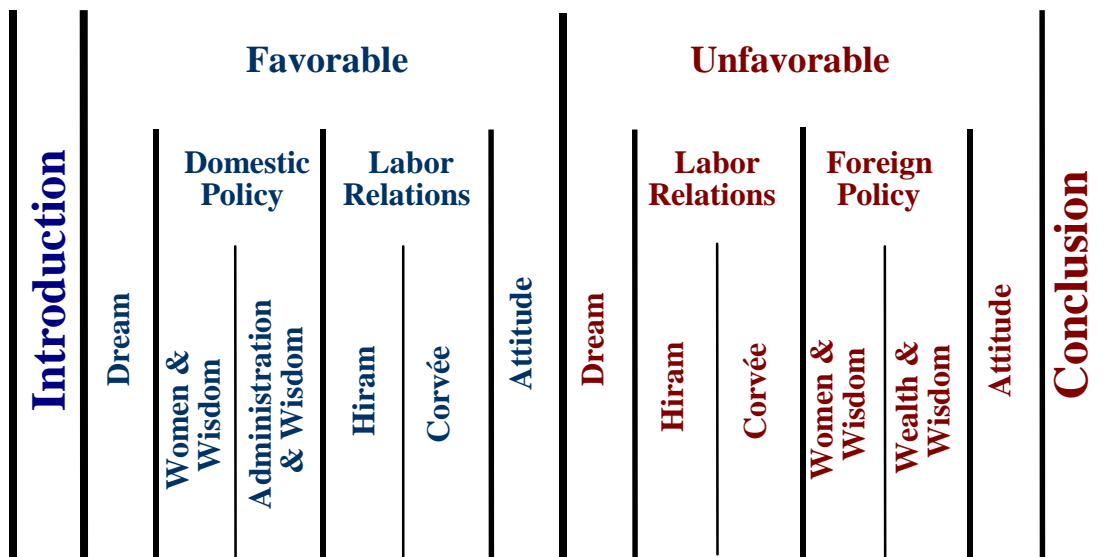

### A. SOLOMON'S SUCCESSION TO DAVID'S THRONE 1:1—2:12

The first segment of the writer's story (1:1—2:12) continues the history of Israel's monarchy where 2 Samuel ended. It records the final events in David's reign that led to Solomon's succession to the throne. It answers the question raised in 2 Samuel 9—20, namely, "Who will succeed David?" Similarly, Genesis 12—22 answers the question, "Who will be Abram's heir?"

<sup>27</sup>Kim Ian Parker, "Repetition as a Structuring Device in 1 Kings 1—11," *Journal for the Study of the Old Testament* 42 (October 1988):19-27.

### **1. David's declining health 1:1-4**

It was customary in ancient times to warm an elderly person not only by covering him or her with blankets, but also by putting a healthy person in bed with him or her.<sup>28</sup> The body heat of the well person would keep the older person warmer. David's physicians chose Abishag to provide nursing care for David as well as to warm him. Since David was the king, they sought and found a beautiful nurse for him. In view of David's symptoms, he may have suffered from arteriosclerosis.<sup>29</sup>

"Shunammite" is an alternate reading of "Shulammite," a resident of Shunem in Issachar. There is no way of telling if Abishag was the Shulammite Solomon loved and wrote of in the Song of Solomon (Song of Sol. 6:13). The fact that David did not have sexual relations with this "very beautiful" young woman (v. 4) is significant because it shows that his physical powers were now weak. David had been sexually active, but now his sexual powers were depleted. This shows that it was time for a more energetic man to reign.

### **2. Adonijah's attempt to seize the throne 1:5-53**

Adonijah ("Yahweh is lord") was David's fourth son (2 Sam. 3:4) and the eldest one living at this time. Evidently he believed it was more important that the eldest son succeed David, as was customary in the Near East, than that the king of Yahweh's anointing occupy that position. God had identified Solomon as David's successor even before Solomon was born (1 Chron. 22:9-10). Adonijah's revolt was primarily against the revealed will of God, secondarily against David, and finally against Solomon.

*"His father had never interfered with him or 'crossed him' (NASB) is more descriptive than 'displeased him' (RSV), for this comment by the author (cf. vv. 8, 10) betrays David's weakness in his unwillingness to cause his children any physical or mental discomfort . . ."*<sup>30</sup>

Adonijah prepared to seize David's throne as Absalom had attempted to do (cf. 2 Sam. 15:1). Joab had long since demonstrated his disregard for God's will in many instances (2 Sam. 3:22-30; 18:5-15; 20:8-10). He evidently sided with Adonijah now because he realized he was out of favor with David. If Solomon succeeded to the throne, he would probably demote Joab at least.

Abiathar had been the leading priest in Israel until David began to give Zadok priority. He had fled from Nob, after Saul massacred the priests there, to join David in the wilderness (1 Sam. 22:18-20). He had also offered sacrifices at David's tabernacle in Jerusalem while Zadok served at the Mosaic tabernacle at Gibeon. However, David had been showing increasing favor to Zadok (cf. 1 Chron. 15:11; 2 Sam. 15:24; 20:25). Abiathar was one of Eli's descendants whom God had doomed with removal from the

<sup>28</sup>Wiseman, p. 67.

<sup>29</sup>Gene Rice, *Nations under God*, p. 8; and Simon DeVries, *1 Kings*, p. 12.

<sup>30</sup>Wiseman, p. 69.

priesthood (1 Sam. 2:30-36; cf. 1 Kings 2:27). Probably Abiathar saw in Adonijah's rebellion a promising opportunity to retain his position that he must have seen he would lose if Solomon came to power.

Shimei (v. 8; cf. 2 Sam. 16:5-13; 19:16-23) may have been truly loyal to David at this time, or he may have simply supported David for the sake of personal advantage (cf. 2:36-38).

Adonijah's banquet at En-rogel, just a few hundred yards southeast of the City of David, was probably a covenant meal at which his supporters pledged their allegiance to David's eldest living son. If David's other supporters had attended and eaten with Adonijah, custom would have bound them to support and protect one another.<sup>31</sup>

As a prophet, Nathan spoke for God. The term "prophet" occurs 94 times in Kings, and "man of God," a prophetic title, 60 times. There are four varieties of prophets in Kings: lone figures who spoke for God (e.g., Elijah), court prophets (e.g., Nathan), writing prophets (writers of the inspired OT books), and prophetic groups (e.g., schools of prophets, and sons of the prophets).<sup>32</sup> Some prophets also served as worship leaders (1 Chron. 25:1).

Evidently God moved Nathan to do what he did here. It was certainly in harmony with God's will (cf. 2 Sam. 12:1). Adonijah had become king (v. 11) only in the sense that he was the people's choice at that moment. Perhaps Nathan was trying to shock Bathsheba and David by referring to Adonijah as the king.

David had undoubtedly assured Bathsheba that Solomon would succeed him after God had revealed that to David (1 Chron. 22:9-10). Nathan wanted to make sure at least two witnesses would hear David's promise that Solomon was his choice (cf. Num. 35:30; Deut. 17:6; 19:15). This was especially important since Adonijah's rebellion against the Lord's anointed was a capital offense.

We should probably interpret Bathsheba's request (v. 20) as a desire that David would appoint Solomon co-regent rather than that he should step down and let Solomon rule in his place.<sup>33</sup> According to Josephus, Solomon was David's youngest son.<sup>34</sup> But this tradition lacks biblical support (cf. 2 Sam. 5:14-16).

Normally in the ancient Near East a new king would purge his political enemies when he came to power (cf. 2:13-46). This was the basis for Bathsheba's fear (v. 21). Nathan's news that Adonijah's feast was taking place at that very moment (v. 25) would have encouraged David to act at once. Nathan's words to David (vv. 24-27) were very diplomatic and appropriate for a man in his position.

---

<sup>31</sup>Gray, p. 87.

<sup>32</sup>Howard, pp. 190-92.

<sup>33</sup>E. Ball, "The Co-Regency of David and Solomon (1 Kings 1)," *Vetus Testamentum* 27:3 (July 1977):269. Cf. Gray, p. 88.

<sup>34</sup>Flavius Josephus, *Antiquities of the Jews*, 7:14:2.

The clause, "May the king live forever," (vv. 31, 34; et al.) occurs often in the Old Testament. It expresses the wish that, because the king had acted or would act righteously, God would bless him with long life. God had promised righteous Israelites long life under the Mosaic Law. It also expressed the desire that David might live forever through the lives of his descendants.

Zadok, Nathan, and Benaiah were the highest ranking priest, prophet, and soldier respectively. Their leadership in the events David ordered (vv. 32-35) would have shown the people that they were acting as King David's representatives. Kings often rode on mules in the ancient Near East, symbolizing their role as servants of the people (v. 33). The Gihon ("gusher") spring (v. 33) was the other main water source for Jerusalem besides En-rogel ("spring of the foot"). It was one-half mile north of En-rogel on the eastern side of Zion, and it was visible from En-rogel.<sup>35</sup>

Zadok the high priest anointed (consecrated) Solomon king of Israel there (vv. 34, 39) with oil from David's tabernacle (v. 39), symbolizing Solomon's endowment with God's Spirit for service (cf. 1 Sam. 10:1; 16:3, 12). At the same time someone anointed Zadok as high priest (1 Chron. 29:22). A trumpet blast (vv. 34, 39) often announced God's activity in Israel throughout its history (Exod. 19:16; et al.), as it did here.

"Two terms are used for the royal office: 'king' (1 Kgs. 1:34, 35a) and 'ruler' (v. 35b). 'King' (*melek*) had a long history of usage and carried with it associations of autocracy and despotism from the practice of kingship among Israel's neighbors. 'Ruler' (*nagid*, translated elsewhere as 'prince' or 'leader'), a term unique to Israelite tradition, emphasizes that one rules at God's appointment and pleasure (cf. 1 Sam. 9:16; 10:1; 13:14; 25:30; 2 Sam. 7:8; 1 Kgs. 14:7; 16:2). These two terms anticipate the long struggle between the ideal and the practice of kingship in Israel."<sup>36</sup>

By anointing Solomon (v. 39, in 973 B.C.), the high priest identified him as David's successor. Solomon now took his seat on Israel's throne as David's co-regent (v. 46).

"The exact relationship between David and Solomon during the period of coregency is not made clear. Normally in such coregencies, the father remained in supreme command as long as he lived, with the son more or less carrying out his directives. This probably was true with David and Solomon also, though the fact that David was bedridden during this time suggests such an arrangement may have been more theoretical than actual."<sup>37</sup>

David thanked God for allowing him to live to see Solomon's coronation (v. 48).

---

<sup>35</sup>See Hershel Shanks, *The City of David*, pp. 38-39.

<sup>36</sup>Rice, p. 15.

<sup>37</sup>Leon J. Wood, *Israel's United Monarchy*, p. 301.

"The placing of Solomon on the throne signals the beginning of the Davidic dynasty, a royal lineage that will eventually produce Jesus Christ. God has begun to keep the promises made to David in 2 Sam 7:7-17."<sup>38</sup>

Some commentators believed this was Solomon's second anointing, when he became the sole king over Israel (in 971 B.C.).<sup>39</sup> It seems more likely, however, that David did not die for some time after the events described in chapter 1 (i.e., for two years; cf. 2:10-12).

Adonijah fled to the sanctuary courtyard, evidently the one in Jerusalem, and took hold of the horns on the brazen altar. In the ancient Near East and in Israel, people customarily regarded the central sanctuary as a place of refuge (Exod. 21:14; cf. Ezek. 21:1-3). The name "sanctuary" to describe a church originated in the Middle Ages.<sup>40</sup> The idea behind this custom seems to have been that God had been gracious to people by accepting their offerings. Consequently, people should be gracious to the refugee who had offended his fellow man. Solomon, like David and like Yahweh, showed mercy (v. 52).<sup>41</sup>

"The central truth for the throne-succession historian is that Yahweh was at work to frustrate Adonijah and to establish Solomon."<sup>42</sup>

Solomon's succession was not a smooth transition. Solomon was God's choice to succeed David, but he was not the oldest son of David, so his succession was unnatural. Like so many others before him, God sovereignly chose to place an unusual choice in a position of blessing instead of what was traditional (cf. Isaac over Ishmael, Jacob over Esau, Joseph over Reuben, Ephraim over Manasseh). In all these cases, and in Solomon's, various individuals resisted the will of God because they wanted what was traditional (customary).

Solomon's succession was also unusual in that Solomon was the son of Bathsheba, whom David should not have married. We might think that God would have punished David for his sin with Bathsheba by choosing one of David's sons by another wife, perhaps his first wife, to succeed him. But God's choices are sovereign. He sometimes chooses to bless greatly those who have sinned greatly, in spite of their sins. Indeed, He seems to delight in doing this (cf. Moses, Paul). God's great grace to sinners stands out even more greatly when He blesses greatly those whom He has forgiven much. As Jesus said, it is those who have been forgiven much that love much (Luke 7:47). Perhaps we do not love the Lord as much as we could because we do not appreciate how much He has forgiven us.

### **3. David's charge to Solomon 2:1-9**

David's words here recall Moses' final words to the Israelites (Deut. 31:6), as well as the Lord's instructions to Joshua (Josh. 1:1-9). They state succinctly the philosophy of history the writer of Kings set forth in this book. It is the philosophy David had learned and now

---

<sup>38</sup>House, p. 93.

<sup>39</sup>E.g., H. C. M. Williamson, *1 and 2 Chronicles*, pp. 186-87.

<sup>40</sup>Wiseman, p. 74.

<sup>41</sup>For an interesting study of chapter 1 as a complete story containing background, complication, climax, and denouement, see Burke O. Long, "A Darkness Between Brothers: Solomon and Adonijah," *Journal for the Study of the Old Testament* 19 (February 1981):79-94.

<sup>42</sup>DeVries, p. 22.

commended to his son Solomon. Careful obedience to the Law of Moses would yield success in all areas of his son's life (v. 2). That obedience would constitute his manhood (v. 1). Since God made man in the image of God, man can realize his manhood only by placing himself under God's authority. "Statutes," "commandments," "ordinances," and "testimonies" are all different kinds of precepts in the Law. Solomon's faithful obedience would also ensure an unbroken line of rulers (v. 4; implied in 2 Sam. 7:12-16). Compare other important farewell addresses such as those by Jacob (Gen. 47:29—49:33) and Joshua (Josh. 23:1-16), as well as God's charge to Joshua (Josh. 1:1-9).

"Indeed, this consideration makes a true king: to recognize himself a minister of God in governing his kingdom. Now, that king who in ruling over his realm does not serve God's glory exercises not kingly rule but brigandage. Furthermore, he is deceived who looks for enduring prosperity in his kingdom when it is not ruled by God's scepter, that is, His Holy Word; for the heavenly oracle that proclaims that 'where prophecy fails the people are scattered' [Prov. 29:18] cannot lie."<sup>43</sup>

David also gave Solomon advice concerning certain men. Solomon should execute Joab for his murders (2 Sam. 3:22-30; 20:8-10). David had been merciful to Joab who was living on borrowed time because of his service to David. Nevertheless he deserved to die so justice would prevail. Evidently David had reason to believe Shimei the Benjamite would threaten the throne again (cf. 2 Sam. 16:11). If he did, Solomon was to execute him (v. 9; cf. vv. 36-46). We see here (vv. 1-9) another instance of the theme that punishment comes on those who resist the Lord's anointed and blessing follows those who serve him.

"David was wrong in passing on responsibility to Solomon to execute the judgment he himself should have ordered at the time. This was to cause his son and successors much trouble and feuding."<sup>44</sup>

"In a scene that could have come straight from *The Godfather*, his [Solomon's] father, on his deathbed, transfers the authority of kingship to him with instructions to kill the rivals that could challenge Solomon's rule. The aged patriarch whispers their names with his last breath."<sup>45</sup>

#### **4. David's death 2:10-12**

David and Saul each reigned for 40 years (cf. Acts 13:21). The differences in their personal lives and administrations were not due to differences in the time they ruled. The course of their careers sprang from God's response to them that their response to Yahweh's will determined. David experienced God's blessing as a warrior, poet, musician, military commander, administrator, and man of God. His most significant characteristic, I believe, was his heart for God.

---

<sup>43</sup>John Calvin, "Prefatory Address to King Francis I of France," sec. 2, in *Institutes of the Christian Religion*.

<sup>44</sup>Wiseman, p. 77.

<sup>45</sup>Craig Glickman, *Solomon's Song of Love*, p. 12.

David was 70 years old when he died (2 Sam. 5:4). Saul may have been 80 when he died.<sup>46</sup> However, the deaths of these two kings, as well as their lives, contrast dramatically. David died in peace, Saul in battle. David died in victory, Saul in defeat. When David began to reign, the Philistines dominated Israel. When Solomon began to reign, Israel was at peace and in control of her neighbors (v. 12).

Josephus wrote that David "had great and immense wealth buried with him" and, centuries later, on more than one occasion, vast riches were removed from his tomb.<sup>47</sup> But there is no biblical statement to that effect.

This section (1:1—2:12) provides a bridge between David and Solomon's reigns.<sup>48</sup> Much in it is transitional, dealing with the transfer of power. When Solomon began to reign as sole king in 971 B.C., he had a strong foundation on which to build because of the blessing God had brought to Israel for David's commitment to God and His Law.<sup>49</sup>

## **B. THE FOUNDATION OF SOLOMON'S REIGN 2:13—4:34**

The writer noted that Solomon's sole reign began well. The things most responsible were God's gift of wisdom to Solomon (the central section), his political decisions (the first section), and his administrative ability (the third section).

### **1. Solomon's purges 2:13-46**

Solomon wrote that the fear of Yahweh is the beginning of knowledge (Prov. 1:7; cf. Eccles. 12:13; Ps. 111:10). At the very beginning of his reign he gave evidence of being wise by the way he dealt with his political enemies. His wise decisions at this time resulted in peace and prosperity for Israel for the next 40 years (971-931 B.C.).

#### **Adonijah's execution 2:13-25**

Adonijah's professed acceptance of Solomon's succession overcame Bathsheba's initial fear of him. He convinced her that he only wanted permission to marry King David's former nurse. But Solomon saw deeper into Adonijah's intent. Even though David had not had sexual relations with Abishag, she was part of his harem, one of the women who ministered to his most intimate needs.

"Although Abishag had been only David's nurse, in the eyes of the people she passed as his concubine; and among the Israelites, just as with the ancient Persians (Herod. iii. 68), taking possession of the harem of a deceased king was equivalent to an establishment of the claim to the throne . . ."<sup>50</sup>

<sup>46</sup>See my comments on 1 Sam. 13:1.

<sup>47</sup>Josephus, 7:15:3. Cf. *ibid.*, 13:8:4; and *idem*, *The Wars of the Jews*, 1:2:5.

<sup>48</sup>For an extended treatment of the two halves of chapter 2, see Jeffrey S. Rogers, "Narrative Stock and Deuteronomistic Elaboration in 1 Kings 2," *Catholic Biblical Quarterly* 50:3 (July 1988):398-413.

<sup>49</sup>See Kenneth A. Kitchen, "How We Know When Solomon Ruled," *Biblical Archaeology Review* 27:5 (September/October 2001):32-37, 58.

<sup>50</sup>C. F. Keil, *The Books of the Kings*, p. 32.



Adonijah would also have found popular support among the people because he was David's oldest living son (cf. v. 22). Solomon correctly regarded Adonijah's request as an act of treason worthy of death.

Verse 24 makes it very clear that Solomon, like David, had a proper view of his role under God as Israel's king. Adonijah's rebellion was not just against Solomon personally but against the Lord and His anointed whom He had placed on the throne.

### **Abiathar's dismissal 2:26-27**

Solomon granted Abiathar a parole for participating in Adonijah's rebellion. By removing him from his office, he cut off Eli's last descendant, thereby fulfilling God's prophecy to Eli (1 Sam. 2:27-36). Eli's fertility ended because he had not obeyed God's Law faithfully. The writer of Kings drew special attention to God bringing this to pass (v. 27).

### **Joab's execution 2:28-35**

Perhaps because Solomon had shown Adonijah mercy when he fled to the altar (1:50-52), Joab sought refuge from Solomon there too, for participating in Adonijah's rebellion. Joab, however, was a murderer as well as a rebel. Consequently Solomon had him executed in obedience to the Mosaic Law (Exod. 21:14). Manslayers, but not murderers, found sanctuary at the altar. David's house shared the guilt for Joab's murders as long as he remained alive (v. 31). By executing Joab, Solomon cleared the way for God to bless him and his throne. God would punish Joab's house but bless David's house (v. 33). Solomon honored Joab for his service to David by burying him in his own land in Judah (v. 34; cf. 2 Sam. 2:32).

### **Shimei's execution 2:36-46**

David had warned Solomon to keep Shimei under close observation and to put him to death (vv. 8-9). Evidently David realized, because of Shimei's past actions, that it would only be a matter of time before he would do something worthy of death, probably rebel against Solomon's authority. Solomon therefore made Jerusalem Shimei's prison. Jerusalem was only "a small acropolis city, whose circumference has been estimated at 4500 feet."<sup>51</sup> Solomon kept Shimei from reuniting with his Benjamite kinsmen. When Shimei left the city he flagrantly rebelled against Solomon's authority. Leaving the city in itself was no great crime, but the fact that Solomon had specifically forbidden it made it very serious. Thus Shimei's disregard for and disobedience to the will of the Lord's anointed resulted in his death.

All of Solomon's dealings with these enemies, who had conspired against the Lord's anointed and violated the Mosaic Law, show that the new king had a firm commitment to keeping that Law. Moreover Solomon was also merciful and wise, traits of God Himself, who blessed Solomon with these characteristics as His son because of Solomon's commitment to Him. This section also vividly portrays the fate of people who oppose

---

<sup>51</sup>James A. Montgomery, *A Critical and Exegetical Commentary on the Books of Kings*, p. 96.

God: disenfranchisement (in the case of Abiathar) and death (in the cases of Adonijah, Joab, and Shimei).

"Taken as a whole, 2 Sam. 9—20; 1 Kgs. 1—2 is one of the most powerful indictments of sin in the Bible. But this material has to do with more than judgment. Running parallel to the nemesis of judgment are the grace and providence of God. The child born of the adulterous union died, but another son was born to David and Bathsheba (2 Sam. 12:15-25). David almost lost his kingdom to Absalom, but God defeated the counsel of Ahithophel and David regained his throne (2 Sam. 16:15—17:14). The ultimate good in this tangle of events was the accession of that son of David whom the LORD loved ([chose] 2 Sam. 12:24-25), who ended the disruption in David's family and established the kingdom in strength and peace. Good and evil mingle together in these events. But God is able to achieve his purposes in the midst of and in spite of evil. Even that which is meant for evil God can turn to good (Gen. 45:8; 50:20; Ps. 76:9). The supreme example of this, of course, was the turning of Good Friday into Easter."<sup>52</sup>

"The major canonical and theological issue this section raises is the fulfillment of the Davidic Covenant."<sup>53</sup>

"Historically, Israel is at a crossroads. From this moment on one sees a drastic shift from semidemocratic tribal rule (maintained to some extent in David's administration) to a typical despotic city-state."<sup>54</sup>

### **2. Solomon's wisdom from God ch. 3**

The flowing narrative of chapters 1—2 now gives way to reports and lists that catalogue facts about Solomon's reign.

The writer constructed the Solomon narrative (chs. 3—11), like so many others in the Old Testament, to draw attention to the fulfillment or lack of fulfillment of prophecies made earlier.<sup>55</sup> The prophecy lies in 3:3-14, and we can trace the fulfillment through chapter 11.

This chapter emphasizes one of the chief blessings God bestowed on Solomon for his commitment and submission to Yahweh. By giving Solomon unusual wisdom God also blessed the nation he served as king.

---

<sup>52</sup>Rice, pp. 27-28. For a good discussion of the "succession narrative" that begins in 2 Samuel 9—20 and concludes with 1 Kings 1—2, see Patterson and Austel, p. 38.

<sup>53</sup>House, p. 103.

<sup>54</sup>DeVries, p. 44.

<sup>55</sup>Bezalel Porten gave a detailed analysis of the structure of this section that substantiates this claim in "The Structure and Theme of the Solomon Narrative (1 Kings 3-11)," *Hebrew Union College Annual* 38 (1967):93-128.

"The characteristics of Solomon's wisdom and glory were not selected just to continue the picture of an ideal king by showing him in a favourable light. Throughout, and in the epilogue on his reign (11:1-13, 33), the history comments on its deficiencies in theological terms. A similar appraisal will be used to judge successive rulers against the reigns of David and Solomon."<sup>56</sup>

### Solomon's attitudes 3:1-3

Should Solomon have married "Moabite, Ammonite, Edomite, Sidonian, and Hittite women," as well as Pharaoh's daughter? In view of Exodus 23:31-33, 34:12-16, and Deuteronomy 17:17, there is no way we can say yes. Why then did the writer not point out this sin here? He may have not done so because his purpose in this part of his history was to show the greatness of Solomon. In chapter 11 he emphasized Solomon's failures. Here it is the fact that he could marry such a person as an Egyptian princess, that shows the social and political height to which God had elevated him. A descendant of former Egyptian slaves now became Pharaoh's son-in-law!

"Under Solomon, the relationship between Egypt and Israel reached an apex with the marriage alliance between the two nations (1 Kgs 3:1)."<sup>57</sup>

"This illustrates both the relative importance of Israel and the low estate to which Egypt had sunk: Pharaohs of the Empire did not give their daughters even to kings of Babylon or Mitanni!"<sup>58</sup>

At this time Israel was stronger than Egypt.

"That this is the case is clear from his [Pharaoh Siamun's, 978-959 B.C.] willingness to provide his own daughter as a wife for Solomon, a concession almost without parallel in Egyptian history since it was a candid admission to the world of Egypt's weakness and conciliation. Normally Egyptian kings took foreign princesses but did not give up their own daughters to foreign kings."<sup>59</sup>

There is much evidence of the immense influence and prestige that Solomon enjoyed in his day.<sup>60</sup> Solomon housed his bride in the City of David until he completed a special palace for her nearby (7:8).

---

<sup>56</sup>Wiseman, p. 81.

<sup>57</sup>James K. Hoffmeier, "Egypt As an Arm of Flesh: A Prophetic Response," in *Israel's Apostasy and Restoration: Essays in Honor of Roland K. Harrison*, p. 81.

<sup>58</sup>John Bright, *A History of Israel*, p. 191.

<sup>59</sup>Eugene H. Merrill, *Kingdom of Priests*, p. 292. Cf. Alan Schulman, "Diplomatic Marriage in the Egyptian New Kingdom," *Journal of Near Eastern Studies* 38 (1979):190-91.

<sup>60</sup>See Alberto Green, "Israelite Influence at Shishak's Court?" *Bulletin of the American Schools of Oriental Research* 233 (1979):59-62.

Josephus commented on the writer's statement that "he [Solomon] . . . finished building . . . the wall around Jerusalem" (v. 1) as follows:

". . . he . . . built the walls of Jerusalem much larger and stronger than those that had been before . . ." <sup>61</sup>

The Israelites were offering sacrifices to Yahweh on the "high places" that the Ras Shamra tablets describe as open-air sanctuaries throughout the land. The Ras Shamra tables are important inscriptions that archaeologists discovered at the Canaanite site of Ugarit, just east of Cyprus on the Mediterranean coast. They contain much helpful information about Canaanite life and culture. These sacrificial sites were normally on hilltops. The Israelites evidently took them over from the Canaanites and converted them into centers of Yahweh worship. Before the giving of the Mosaic Law, worship on high places was not evil (cf. Gen. 12:7-8; 22:2-4; 31:54). However, the Law forbade offering sacrifices at places other than those God approved, and especially at sites of Canaanite altars, after Israel built the temple in Jerusalem (Deut. 12:1-21; 2 Chron. 7:12). Evidently at this time the people justified their disobedience on the ground that they did not have a permanent palace where Yahweh could dwell (i.e., a temple). Another possibility is that they did not consider worship at high places wrong until the king reunited the ark and a tabernacle in a central sanctuary (i.e., the temple; cf. 1 Sam. 9:11-25).<sup>62</sup>

The only deviation from the Law that the writer ascribed to Solomon at this early time in his reign was his worship at the high places (v. 3). Otherwise Solomon followed God faithfully, except for his polygamy.

"Silently, invisibly, like an incubating virus, sin was at work throughout Solomon's reign and in the end broke out in violent, destructive force. Such is the nature of sin."<sup>63</sup>

Love here (v. 3) does not express a feeling only but more fundamentally a commitment to Yahweh that manifests itself in obedience to His Word (cf. 1 John 5:3). Solomon's commitment, like David's, accounted for much of the blessing that came on the king and through him to the people.

### **Solomon's petition for wisdom 3:4-15**

A tabernacle, evidently the Mosaic tabernacle, and the Mosaic tabernacle's bronze altar still stood at Gibeon (lit. little hill; 1 Chron. 16:39-40; 21:28-29; 2 Chron. 1:3, 5-6). (However, Josephus wrote, apparently incorrectly, that the brazen altar that Moses built was at Hebron.<sup>64</sup>) Gibeon was one of the so-called high places where the people offered sacrifices to Yahweh. Burnt offerings symbolized the dedication of the worshipper's person to God (Lev. 1). By offering 1,000 of these sacrifices Solomon was expressing his personal allegiance to Yahweh (cf. Rom. 12:1-2).

---

<sup>61</sup>Josephus, *Antiquities of . . .*, 8:2:1. Cf. Ps. 51:18.

<sup>62</sup>Patterson and Austel, p. 44.

<sup>63</sup>Rice, p. 31.

<sup>64</sup>Josephus, *Antiquities of . . .*, 8:2:1.

God responded by blessing Solomon in a way that He would not have had the king failed to dedicate himself to God. God's revelation to him was in response to his offerings. God's offer constituted a test for Solomon (v. 5). Would he request something for his own glory or for God's glory? He showed his heart for God by asking something for God's glory (v. 9). His words show that he viewed himself as dependent on God, not self-sufficient (v. 7), God's servant (vv. 8-9), and a servant of God's people rather than his people (v. 9). In verse 7 the Hebrew word *na'ar*, translated "little child" (NASB, NIV, NKJV), means immature person. Solomon acknowledged God's past action, asked for His continuing favor, expressed humility, and requested the ability to carry out his duties.<sup>65</sup>

"To go out and to come in' [v. 7] refers to life beyond the doors of one's household and the city gate in the discharge of one's duties (Deut. 31:2; 1 Sam. 18:16)."<sup>66</sup>

This is an idiom that refers to the skills of leadership (cf. Num. 27:17; Josh. 14:11; 1 Sam. 29:6; 2 Kings 11:8).<sup>67</sup> Solomon also requested an understanding (lit. a listening or obedient) heart (v. 9). Significantly, in Hebrew, "hearing" and "obeying" come from the same word. Furthermore, Solomon viewed God as lovingly loyal, just, and gracious (v. 6), his God (v. 7), and the true King of Israel (vv. 8-9).<sup>68</sup>

"The heart (*leb*) in Israelite thought is the center of the psychic self. It includes especially mental activity but is broader in scope than English 'mind,' embracing the feelings and will as well. The heart is susceptible to become hardened, to be made fat (Isa. 6:10), and to dwell on evil (Gen. 6:5; 8:21); indeed, it is 'deceitful above all things' (Jer. 17:9). It is over against these capabilities of the heart that Solomon's request is to be understood. A 'hearing heart' [v. 9] is one that is open, receptive, teachable (Isa. 50:4). That to which the heart of the king should be open above all else is God's *torah*. The king ideally rules not on the basis of his own understanding but administers his realm in the light of God's revealed will."<sup>69</sup>

"The king was the supreme judge and final arbiter. Within his domain, the ideal king sought to achieve what was right, to vindicate the just, to protect the rights of the weak. And this was achieved in practice by a series of shrewd and just decisions or verdicts or judgments (*mishpatim* in the plural) all of which are examples of what our text calls 'right' (*mishpat* in the singular)."<sup>70</sup>

<sup>65</sup>Wiseman, pp. 84-85.

<sup>66</sup>Rice, p. 33.

<sup>67</sup>House, p. 110.

<sup>68</sup>For a good explanation of the meaning of *hesed* ("lovingkindness," v. 6), see Patterson and Austel, p. 47.

<sup>69</sup>Rice, p. 34.

<sup>70</sup>A. Graeme Auld, *I and II Kings*, p. 23. J. Sidlow Baxter, *Explore the Book*, 2:99, distinguished between spiritual wisdom (insight into divine things) and practical wisdom (administrative discernment, sagacious judgment, intellectual grasp, aptitude for the acquisition of knowledge, and prudence in the directing of affairs). He claimed, and I agree, that Solomon asked for and received less of the first kind but more of the second kind.

While Solomon's request was good, one cannot help but question if it was as good as Moses' request for an understanding of God and His ways (Exod. 33:13). In this we may see a difference between Solomon's heart and Moses' heart. Perhaps we should not be completely surprised, therefore, at the outcome of Solomon's life. He was brilliant, but he was perhaps not as godly. Brilliance is good, but godliness is much better. We cannot do much about our God-given brilliance, but we can do something about our godliness (cf. 1 Tim. 4:8). Nevertheless, the writer said that Solomon loved the LORD and walked in the statutes of his father David (v. 3), so my assessment of his request is tentative.

God promised to bless Solomon for putting His interests before Solomon's (cf. Matt. 6:33). He gave him much more than he asked (v. 13). Furthermore, He promised to give Solomon long life if he continued to obey His Law (v. 14).

Solomon's expression of gratitude included more offerings. He presented these before the ark in Jerusalem. They expressed further personal dedication (the burnt offerings) and gratitude for fellowship with God (the peace offerings). They probably accompanied a covenant renewal ceremony that involved the commitment of his servants (i.e., government officials) to the Mosaic Law (v. 15).

Notice that this section ends as it began: with a journey and sacrifices. This helps the reader identify it as a section, by the *inclusio*.

### **God's provision of wisdom 3:16-28**

This incident demonstrates that God did indeed give Solomon the unusual wisdom He had promised (v. 28).<sup>71</sup> The writer did not specify when during Solomon's reign this event took place, but probably it occurred shortly after God appeared to the king at Gibeon (vv. 4-15).

"The chronology of the reign of Solomon does not pose nearly the difficulty as does that of David. With the exception of the narrative passages, which appear as usual to be inserted topically, the order found in both 1 Kings and 2 Chronicles reflects the general flow of events. It does seem, however, that Solomon's alliance with Siamun of Egypt (1 Kings 3:1) did not come to pass until after he had begun negotiations with the Tyrians to help on the temple. This in turn presupposes Solomon's having sought and been granted wisdom, for Hiram takes note of that fact (1 Kings 5:7)."<sup>72</sup>

Solomon demonstrated insight into basic human nature, here maternal instincts. This insight enabled him to understand why people behave as they do and how they will respond. This was a gift from God and is an aspect of wisdom.

---

<sup>71</sup>Wiseman, pp. 85-86, wrote a short note on the wisdom that is in view here.

<sup>72</sup>Merrill, p. 290.

"The fact that the two mothers were prostitutes is important in this story . . . because it shows how the wise king would act on behalf of the very lowest of his subjects . . ."73

This incident resulted in the Israelites having great respect for their king (v. 31). Solomon became a blessing to the people because he related properly to Yahweh.

Wisdom in Israel and the ancient Near East was not synonymous with knowledge or education. It involved the ability to live life in a skillful way, so at the end, one's life would amount to something worthwhile. To the Israelites this was possible only if a person knew and responded appropriately to (i.e., feared) Yahweh.<sup>74</sup>

### **3. Solomon's political strength ch. 4**

God also blessed Israel through Solomon by giving him wisdom to organize and administer the political affairs of the nation effectively, as this chapter records.

#### **Solomon's chief officials 4:1-6**

Delegation of authority is a mark of wisdom in a person with more to do than he or she can personally manage effectively. Azariah (v. 2) was apparently Zadok's grandson (1 Chron. 6:8-9). "The priest" is a common designation for the high priest. Secretaries (v. 3) prepared official documents and records while recorders (v. 3) maintained diaries of daily events in the kingdom. Even though Solomon had dismissed Abiathar (v. 4) from his official duties, Abiathar retained his title and honor. Zabud (v. 5) was probably the king's personal chaplain and adviser.<sup>75</sup> Forced laborers (corvée, v. 6) were non-Israelites whom the king conscripted to work for the government (cf. 5:13-14; 9:15; 2 Chron. 2:2; 8:8).

#### **Solomon's district governors 4:7-19**

These men were responsible for providing for the needs of Solomon's large household, including his courtiers, and for his thousands of horses (v. 28). Two were Solomon's sons-in-law (vv. 11, 15). The district arrangement seems designed to move Israel away from tribal independence to cooperation under the new centralized government. Though the district boundaries approximated the tribal boundaries, they were not the same.<sup>76</sup>

". . . this was a radical and decisive step, and that not only because it imposed upon the people an unprecedented burden. It meant that the old tribal system, already increasingly of vestigial significance, had been, as

---

<sup>73</sup>DeVries, p. 61.

<sup>74</sup>See James L. Crenshaw, *Old Testament Wisdom: An Introduction*.

<sup>75</sup>See A. Van Selms, "The Origin of the Title 'The King's Friend,'" *Journal of Near Eastern Studies* 16 (1957):118-23.

<sup>76</sup>See the map "Solomon's 12 Districts and Surrounding Nations" in *The Bible Knowledge Commentary: Old Testament*, p. 496; or the map "Solomon's Administrative Districts" in *The Nelson . . .*, p. 565.

far as its political functioning was concerned, virtually abolished. In place of twelve tribes caring in turn for the central shrine were twelve districts taxed for the support of Solomon's court!"<sup>77</sup>

The writer did not include Judah and Jerusalem in this list of areas that Solomon taxed. This gave Judah a great advantage economically. Perhaps Solomon favored Judah because it was his tribe. This favoritism may have been a factor in the revolt of the northern tribes later (12:4).

Solomon's throne exercised four spheres of political influence. First, there was the homeland. This was the geographical area Joshua had assigned to the 12 tribes. In Solomon's day Israel occupied only this area. Second, there were adjacent provinces (i.e., Damascus, Ammon, Moab, Edom, et al.). Solomon taxed these and conscripted them for military service. They enjoyed protection and the benefits of Israel's central government. Third, there were the vassal states (i.e., Zobah, Hamath, Arabia, possibly Philistia, et al.) that Israel controlled. These enjoyed some autonomy such as native rulers and internal fiscal policies. They recognized Solomon's authority, however, provided some tribute, and pledged loyalty to him. Israel in return defended them from alien forces when necessary. Fourth, there were the allied states (i.e., Phoenicia, Egypt, et al.). These countries enjoyed equality with Israel. They defended each other as needed, traded with each other, and generally cooperated with one another.<sup>78</sup>

Clearly Solomon's kingdom had a large bureaucracy.

### **Solomon's prosperity 4:20-28**

One explanation of the writer's unusual reference to Judah and Israel (v. 20) is that when he wrote Kings the nation had split, so perhaps the writer was using the designation that was common in his day. However, years before the formal division took place, northern and southern factions had already developed (cf. 1 Sam. 11:8; 15:4; 17:52; 1 Kings 1:35; et al.). Solomon's kingdom was very populous (cf. Gen. 22:17) and peaceful (v. 25; cf. Micah 4:4; Zech. 3:10).

Usually when a great king died, the nations subject to his leadership would withhold taxes and rebel against his successor. This forced the new king to attack those nations to establish his sovereignty over them. However, Solomon did not have to do this. God gave him a peaceful reign in which he could concentrate on building projects.<sup>79</sup>

"To live *in safety*, in reliance on God (LXX *elpizo*, 'hope'), echoes Deuteronomy 12:10. God alone can provide this (Ps. 4:8; Pr. 1:33; Dt. 33:12, 28)."<sup>80</sup>

---

<sup>77</sup>Bright, p. 201.

<sup>78</sup>Merrill, pp. 300-302.

<sup>79</sup>Patterson and Austel, p. 53.

<sup>80</sup>Wiseman, p. 94.



Even though Solomon controlled the land area promised to Abraham's descendants in Genesis 15:18-20, his control did not fulfill these promises completely in his day. The city of Tiphshah (v. 24) stood on the banks of the Euphrates River. The territory described did not lie within the geographic borders of Israel.<sup>81</sup> Israel's geographic extent was only about 150 miles long, from Dan to Beersheba (v. 25).

The figure of 4,000 stalls of horses (2 Chron. 9:25) appears to be the correct one, rather than 40,000 (v. 26), though Josephus also wrote "40,000".<sup>82</sup> Horses and chariots were military machines at this time. These were Solomon's weapons.

"At Megiddo, excavations have revealed stables for some 450 horses, as well as fortifications and the governor's residence. Similar Solomonic constructions are likewise attested at Hazor, Taanach, Eglon, and Gezer."<sup>83</sup>

### Solomon's skill 4:29-34

Here is more evidence that God gave Solomon wisdom (Heb. *hokmah*) as He had promised (3:12). He was one of the outstanding sages of the ancient world.<sup>84</sup> What Solomon received was the ability to make correct decisions. Even though he possessed this ability he did not always choose to use it. He made some very foolish decisions in his lifetime. The men of the East (cf. Job 1:3) and Egypt (v. 30) were famous for their wisdom in the ancient biblical world.

Solomon's literary output was prolific (v. 32). His name appears on two of the psalms in the Book of Psalms (Ps. 72; 127), and he also evidently wrote the Books of Proverbs, Ecclesiastes, and Song of Solomon. Verse 34 is hyperbole. The writer meant that Solomon's court was open to all and that as a wise man he attracted many important visitors.<sup>85</sup>

Verse 26 says that "Solomon had 40,000 stalls of horses for his chariots." But 2 Chronicles 9:25 says: "Solomon had 4,000 stalls for horses and chariots." Four thousand is probably the correct number, since he had 1,400 chariots (10:26; 2 Chron. 1:14). Three horses were considered a chariot team and would have been quartered together. So "4,000" would be about the number of horses that Solomon needed.<sup>86</sup>

---

<sup>81</sup>See Gwileym Jones, *1 and 2 Kings*, 1:146.

<sup>82</sup>Josephus, *Antiquities of . . .*, 8:2:4.

<sup>83</sup>Bright, p. 192. Cf. William F. Albright, *The Archaeology of Palestine*, pp. 124-25; and Jack Finegan, *Light from the Ancient Past*, pp. 168-69.

<sup>84</sup>See John E. Johnson, "The Old Testament Offices as Paradigm for Pastoral Identity," *Bibliotheca Sacra* 152:606 (April-June 1995):182-200.

<sup>85</sup>John T. Gates, "First and Second Kings," in *The Wycliffe Bible Commentary*, p. 315. Gates wrote the commentary on 1 Kings only in this volume.

<sup>86</sup>*The Nelson . . .*, p. 566.

This chapter shows God's response to Solomon's dedication to Yahweh (3:6-13). Even though Solomon was God's elect, he had the opportunity either to respond properly to God's grace, and experience further blessing, or to respond improperly to it and experience chastening. This is a choice God gives all His elect. Solomon made the wise choice at first but later did not do as well. Solomon's descendant, Jesus Christ, made the perfect response.

### **C. SOLOMON'S GREATEST CONTRIBUTION CHS. 5—8**

Solomon's outstanding contribution to the nation of Israel, I believe, was the provision he made for her spiritual strength. The writer of Kings gave this much emphasis in his book.

People generally regarded their king as the representative, son, and vice-regent of their chief god in the ancient Near East.<sup>87</sup> This was really the true relation of Israel's king to Yahweh. People also viewed the temples of the gods as the palaces of those beings and regarded the magnificence of their houses as a reflection of their personal greatness. The temple represented the god.<sup>88</sup> Therefore Solomon wanted to portray the greatness of Yahweh by building Him the most glorious temple in the ancient Near East. This would have enabled Israel to better fulfill the purpose for which God had raised her up, namely, to bring people to God (Exod. 19:6; cf. Isa. 42:6-7).

#### **1. Preparations for building ch. 5**

##### **Solomon's request of Hiram 5:1-6**

Hiram probably reigned from about 980-947 B.C.<sup>89</sup> Many scholars agree that his reign overlapped David's by about nine years and Solomon's by about 24 (cf. 2 Sam. 5:11). Tyre was an important Mediterranean Sea port in Phoenicia north of Israel. Sidon (v. 6), another, more important Phoenician port city at this time, stood a few miles north of Tyre.

"A house for the name of the Lord" (v. 3) means a house for Yahweh that would communicate His reputation to the world. Cedar (v. 6) is still a favored building material because of its durability and beauty.

##### **Solomon's treaty with Hiram 5:7-12**

The fact that Hiram cooperated with and even blessed Yahweh (v. 7) shows how God brought blessing to Gentiles as well as to the Israelites through David and Solomon's godly dedication to the Lord. The covenant between Israel and Phoenicia (v. 12) resulted in peace for many years.

---

<sup>87</sup>Roland de Vaux, *Ancient Israel: Its Life and Institutions*, 2:282-83.

<sup>88</sup>For an explanation of how ancient Near Easterners viewed their temples, see John M. Lundquist, "Temple, Covenant, and Law in the Ancient Near East and in the Old Testament," in *Israel's Apostasy and Restoration: Essays in Honor of Roland K. Harrison*, pp. 293-305.

<sup>89</sup>Frank M. Cross, "An Interpretation of the Nora Stone," *Bulletin of the American Schools of Oriental Research* 208 (December 1972):17. Cf. Merrill, p. 239.

"Sometimes Solomon has been criticized for entering into such an agreement with an unbelieving pagan like Hiram. Scripture says, 'Be ye not unequally yoked together with unbelievers' (II Cor. 6:14). The principle does not apply in this case, however. Solomon did not join in a partnership with Hiram to build the temple. Solomon built it and merely purchased material and hired workers from Hiram."<sup>90</sup>

### **Solomon's conscription of laborers 5:13-18**

Solomon's forced laborers were non-Israelites (2 Chron. 8:7-8). Israelites also served, but they were not slaves (9:22). Solomon's method of providing workers for state projects became very distasteful to the people eventually, perhaps because of how it was administered (cf. 12:18).

"[Adoniram, also known as Hadoram, 2 Chron. 10:18] was probably one of the most hated men in Israel, an embodiment of autocracy."<sup>91</sup>

Solomon's temple rested on massive limestone blocks that he had quarried out of the hills north of Jerusalem (v. 17). The Gebelites (v. 18) lived in Byblos, 13 miles north of modern Beirut and 60 miles north of Tyre.

The main emphasis in this chapter is on the favorable response of the Phoenician king, Hiram, with which God blessed Israel through Solomon's wisdom (v. 7). Solomon wrote that "when a person's ways please the Lord, He makes even his enemies to be at peace with him" (Prov. 16:7). Such was God's blessing on Solomon at this time.

### **2. Temple construction ch. 6**

After arrangements for building the temple were in order, construction began. This building took seven years to complete (v. 38).

"In an earlier era scholars debunked the reality of a temple in Israel like Solomon's because nothing similar was known from the ancient Near East. However, at 'Ain Dara (and earlier in Tall Ta'yinat), Syria, a temple from the tenth century B.C. came to light that bore a remarkable similarity to the temple of Jerusalem. The size is approximately the same; it consists of two chambers, the Holy Place and the Most Holy Place; and it clearly accommodated cultic features like those described in the Bible. Thus the notion that Israel had a temple in the tenth century rests on firm ground."<sup>92</sup>

### **The outside of the temple 6:1-10**

Verse 1 is one of the most important verses in the Old Testament chronologically. The dates of Solomon's reign (971-931 B.C.) are quite certain. They rest on references that

---

<sup>90</sup>Wood, p. 312.

<sup>91</sup>J. Barton Payne, "Second Chronicles," in *The Wycliffe Bible Commentary*, p. 399. Cf. 1 Kings 4:6.

<sup>92</sup>Eugene Merrill, "The Veracity of the Word: A Summary of Major Archaeological Finds," *Kindred Spirit* 34:3 (Winter 2010):13.

other ancient Near Eastern king lists corroborate.<sup>93</sup> Solomon began temple construction about 966 B.C. According to this verse the Exodus took place in 1445 or 1446 B.C. Most conservative scholars who take statements in Scripture like this verse seriously hold this date for the Exodus. The more popular date of about 1280 B.C. rests primarily on the assumption that Ramses II was the pharaoh of the Exodus. Those who hold this view believe historical similarities between conditions during Ramses' reign and the biblical description of the Exodus support their theory. They usually take the 480 years as a round number representing 12 generations, or as having been arrived at by adding up the lengths of various concurrent or overlapping periods, as though they were placed in one lineal string of years. There are some first-rate otherwise conservative scholars who hold the later (1280) date.<sup>94</sup>

Why did the writer of Kings tie the building of the temple to the Exodus? It was evidently for the reason explained above. With the building of the temple Israel would have an opportunity as never before in her history to realize the purpose for which God had formed and freed the nation. That purpose was to draw all people to Himself.

Josephus tied the beginning of temple construction to several other important events in Old Testament history, though his computations do not seem to be correct.

"Solomon began to build the temple . . . five hundred and ninety-two years after the exodus out of Egypt, but one thousand and twenty years from Abraham's coming out of Mesopotamia into Canaan; and after the Deluge one thousand four hundred and forty years; and from Adam, the first man who was created, until Solomon built the temple, there had passed in all three thousand one hundred and two years. Now that year on which the temple began to be built, was already the eleventh year of the reign of Hiram; but from the building of Tyre to the building of the temple, there had passed two hundred and forty years."<sup>95</sup>

Even though we have some information about the general specifications and appearance of the temple, the omission of other data makes the reproduction of a complete detailed model impossible. Essentially it followed the pattern of both the Mosaic tabernacle and other ancient Near Eastern temples.<sup>96</sup>

The temple was approximately 90 feet long, 30 feet wide, and 45 feet high (v. 2). It had about 2,700 square feet of floor space. Its large open front porch added 15 more feet to its length. It was about twice the size of the Mosaic tabernacle, three times as high, and it faced east, as did the tabernacle and other ancient Near Eastern temples. Solomon's

<sup>93</sup>See also Flavius Josephus, *Against Apion*, 1:17, 18.

<sup>94</sup>E.g., Kenneth A. Kitchen, *Ancient Orient and Old Testament*, pp. 57-75.

<sup>95</sup>Josephus, *Antiquities of . . .*, 8:3:1. See *Dissertation 5: Upon the Chronology of Josephus*, pp. 849-72, in the edition of Josephus' Works cited in the bibliography of these notes.

<sup>96</sup>See William F. Albright, *Archaeology and the Religion of Israel*, pp. 142-56. V. Hurowitz, *I Have Built You an Exalted House: Temple Building in the Bible in Light of Mesopotamian and Northwest Semitic Writing*, is a thorough survey of ancient temple buildings. See also B. Halpern, *The Constitution of the Monarchy in Israel*, pp. 19-24.

temple was similar to other ancient Near Eastern temples in both size and design.<sup>97</sup> This is an example of acculturation: God giving revelation of Himself in forms that were familiar to the original recipients. The exterior of the temple was limestone, cedar, and gold, so it must have been extremely beautiful.

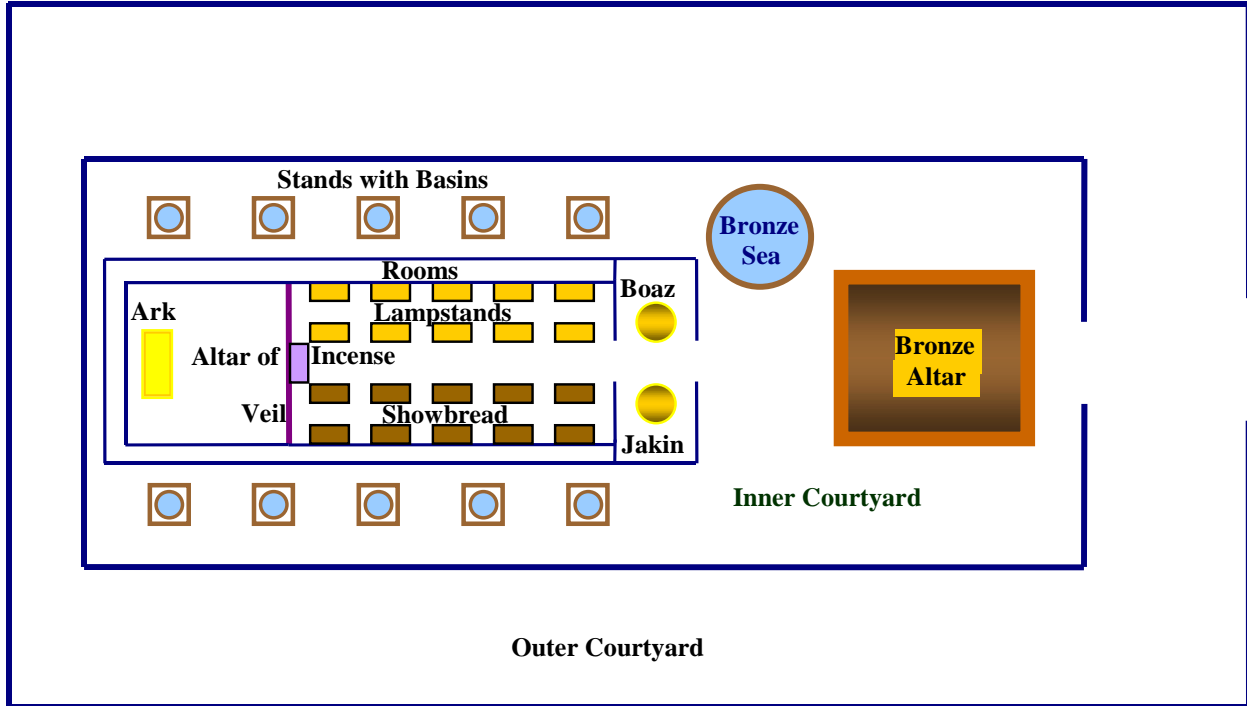

**SOLOMON'S TEMPLE**

On two or three sides there were narrow clerestory windows above the three stories of side rooms that projected from the outer walls. The priests used these side rooms for storage and service purposes. They were apparently smallest on the first floor where there were also hallways and stairways, larger on the second floor that also had halls and stairs, and largest on the third floor. The offset ledges were apparently supports for the upper floors that fastened to the walls of this surrounding structure. Measurements in the text are probably inside dimensions. Josephus described these rooms as follows.

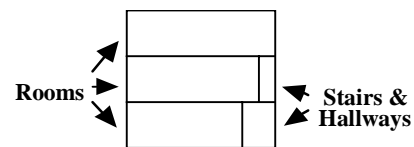

**CROSS SECTION OF SIDE ROOMS**

Josephus' descriptions of the temple's dimensions appear to be inaccurate and confusing. For example:

"He also built round about the temple thirty small rooms . . . Every one of these rooms had five cubits in breadth, and the same in length, but in height twenty. Above these were other rooms, and others above them,

<sup>97</sup>See Hurowitz, pp. 251-546.

equal, both in their measures and number; so that these reached to a height equal to the lower part of the house . . . and truly every one of these rooms had a roof of their own, that was not connected with the other rooms . . ."98

Josephus also wrote that there was another building over the temple, equal to it in its dimensions, and that the entire height of the complex was 120 cubits.<sup>99</sup>

Evidently Solomon wanted to preserve the sanctity of the temple even while it was under construction by eliminating as much noise as possible (v. 7; cf. Deut. 27:5-6).

### **God's promise to bless Solomon's obedience 6:11-13**

Probably this word from the Lord came to Solomon during temple construction. Note that this was a conditional promise based on obedience to the Mosaic Covenant. God would establish Solomon's kingdom forever (i.e., it would remain intact; 2 Sam. 7:13). He would also continue to dwell among the Israelites and not forsake them. Unfortunately, because Solomon did not continue to obey the covenant completely, God divided his kingdom after he died. Because the nation forsook the covenant, God ceased to dwell among the people and forsook them temporarily to captivity (cf. Matt. 28:20).

"Throughout the Solomon stories the author presents an activity, then waits until later to state God's approval or disapproval of it. For example, 3:1-15 expresses approval of Solomon's rise to power in chaps. 1—2, and 5:12 explains that the decisions in 5:1-7 demonstrate God-given wisdom. This strategy continues here, where, through some unspecified manner, Solomon receives God's word about the temple."<sup>100</sup>

The writer evidently inserted this section of text (vv. 11-13) in his description of Solomon's building activities to emphasize the centrality of obedience to the overall success of the project.

### **The inside of the temple 6:14-36**

The altar (vv. 19, 22) refers to the altar of incense (cf. 7:48). This altar evidently stood in the west end of the holy place (cf. Exod. 30:6; 40:5; Lev. 16:2; Heb. 9:4, 7). The cherubim were figures of angels carved out of olive wood (vv. 23-28). They may have resembled "winged sphinxes."<sup>101</sup> Since there were cherubim attached to the mercy seat of the ark, these were two additional freestanding cherubim. In addition to the inner courtyard (v. 36), there was also an outer one (2 Chron. 4:9) that was slightly lower in elevation (Jer. 36:10).<sup>102</sup>

<sup>98</sup>Josephus, *Antiquities of . . .*, 8:3:2.

<sup>99</sup>Ibid.

<sup>100</sup>House, pp. 127-28.

<sup>101</sup>Auld, p. 44.

<sup>102</sup>For more detailed explanation of these verses, see Thomas L. Constable, "1 Kings," in *The Bible Knowledge Commentary: Old Testament*, p. 501.

One problem that continues to puzzle scholars is the difference in height between the holy place (30 cubits or 45 feet, v. 2) and the most holy place (20 cubits or 30 feet, v. 20). Was the floor of the most holy place higher, and were there steps up to it from the holy place? Was the ceiling of the most holy place lower than that of the holy place? Was the most holy place a room within the holy place?<sup>103</sup> We do not know.

Scholars also debate what relationship the row of cedar beams had to the rows of cut stone (v. 36).<sup>104</sup> The cedar beams may have been cedar coping on top of the stone. They may have been cedar that lined the stone interior of the temple. Possibly cedar beams alternated with rows of stone. All of these are possibilities.

### **Summary of the construction 6:37-38**

Seven years is a round number (966-959 B.C.). Actually, completion took seven and one-half years, since Ziv (lit. flowers) is late March and early April, and Bul (lit. moisture) is late October and early November. Probably since most ancient Near Easterners regarded seven as a number symbolic of perfection, the Israelites viewed their temple as a perfect structure.

Why did not God give us more detail? All that the writer recorded of the temple tells us two things about it. We have enough information about the structure so we can find our way around it as we continue reading about it. Furthermore its magnificence as a fitting house for Yahweh, the only true and great God, should impress us.

Archaeologists have never been able to pinpoint the exact location of Solomon's temple. Since Herod built his temple on the site of Nehemiah's temple, and since Nehemiah built his temple on the site of Solomon's temple, there is little question about the general site. It must have been somewhere on the esplanade on which the Dome of the Rock (Mosque of Omar) now stands. Modern Jews pray at the wailing (western) wall because they believe it is the closest site to the holy of holies that is accessible to them. Their rabbis discourage them from walking on the temple esplanade for fear of inadvertently treading on the actual site of the holy of holies. One writer believed the site of the second temple was just north of the Dome of the Rock. He concluded that the site of the holy of holies corresponds to that of the present Dome of the Tablets (also called the Dome of the Spirits).<sup>105</sup> Others believe it was closer to the site of the Dome of the Rock. The "second temple" refers to Nehemiah's temple, which Herod renovated, in contrast to the first or Solomonic temple.

How should what Solomon did in building the temple affect our thinking with regard to modern church architecture? Since there is no earthly central sanctuary for all of Christianity, as there was for ancient Israel, there is no structure that corresponds to

---

<sup>103</sup>Jean Ovellette, "The Solomonic *Debir* according to the Hebrew Text of I Kings 6," *Journal of Biblical Literature* 89:3 (September 1970):338-43.

<sup>104</sup>H. C. Thomson, "A Row of Cedar Beams," *Palestinian Exploration Quarterly* 92 (1960):57-63.

<sup>105</sup>Asher Kaufman, "Where the Ancient Temple of Jerusalem Stood," *Biblical Archaeology Review* 9:2 (March-April 1983):40-59.

Solomon's temple today. But should local churches spend vast quantities of money to build magnificent buildings to honor God? The New Testament does not comment on this, leaving it in the area of freedom for Christians. However, the New Testament teaches that now the universal church, the local congregation, and believers' bodies are all temples of the Holy Spirit (Eph. 2:21; 1 Cor. 3:16; 6:19). We should adorn these temples with conduct that glorifies our God in the sight of onlookers.

### **3. Solomon's palace 7:1-12**

Solomon's palace complex took longer to build than the temple because it was much larger. The king evidently completed the temple and then began work on his palace (cf. 9:10). Solomon seems to have built several separate but interconnected buildings. A large common courtyard evidently surrounded the temple and the palace (v. 12). A similar view is that the palace was one structure and the other buildings were really sections of it.<sup>106</sup> The geographical proximity of the temple and palace visualized the fact that the king was acting for God. We do not know exactly where Solomon placed the palace buildings in relation to each other or to the temple.<sup>107</sup> In the ancient world people regarded a king's palace as some indication of his greatness as well as the greatness of his god.

"Palace and temple complexes are the most important visual symbols of royal power and indicate more precisely the location of the center within a stratified society."<sup>108</sup>

"It [the temple] was not in the midst of the city, like most heathen temples of the time. Its isolation symbolized the uniqueness of the deity to whom it was dedicated."<sup>109</sup>

Certainly Solomon's palace must have been extremely impressive.

"He did everything imaginable to show that, as Yahweh was a great God, he was a great king. What is displayed here is far more Solomon's 'riches and honor' than his 'wisdom.' His was undoubtedly the piety of worldly success."<sup>110</sup>

"The Pillared Hall (called the *Palace of the Forest of Lebanon*) was used as an audience chamber or throne hall, and . . . was larger than the temple. It also served as a state treasury, displaying selected precious objects received as tribute (cf. 10:16-17)."<sup>111</sup>

---

<sup>106</sup>Wood, p. 291, n. 17.

<sup>107</sup>See David Ussishkin, "King Solomon's Palaces," *Biblical Archaeologist* 36 (1973):78-105, for similar temple palace complexes in the ancient Near East.

<sup>108</sup>Keith Whitelam, "The Symbols of Power," *Biblical Archaeologist* 49:3 (September 1986):170.

<sup>109</sup>DeVries, p. 97.

<sup>110</sup>Ibid., p. 103.

<sup>111</sup>Wiseman, p. 111.



Ancient Near Easterners did not view a king's sovereignty as established until he had built a palace for himself.<sup>112</sup> Solomon's palace, therefore, further enhanced his prestige. God blessed Solomon and Israel by allowing him to built it.

#### **4. The temple furnishings 7:13-51**

The people also saw the glory of Yahweh reflected in the furnishings of the temple. These furnishings came from several sources but all contributed to the proper worship of Yahweh.

#### **Furnishings outside the temple 7:13-47**

The Hiram of verse 13 was obviously a different person from the King of Tyre (5:1). God evidently guided this Hiram as he fashioned the furnishings (cf. Exod. 31:1-11).<sup>113</sup>

The two pillars on the temple porch were common features that flanked the main entrances to temples in Syria, Phoenicia, Cyprus, Assyria, and elsewhere in the ancient Near East at this time.<sup>114</sup> Some of these pillars supported the porch roof, but others were freestanding, as these probably were.<sup>115</sup> In various countries they symbolized various things.<sup>116</sup> In Israel their purpose seems to have been to remind the Israelites of Yahweh's establishment of Israel and strength for Israel. Jachin means "He shall establish," and Boaz "In Him is strength" (v. 21).<sup>117</sup> Gray suggested that the pillars symbolized the presence and permanence of Yahweh and the king.<sup>118</sup> Jones argued that they stood for the covenant between Yahweh and His people, especially between Him and the Davidic dynasty.<sup>119</sup> The lily and pomegranate designs probably symbolized the fertility and fruitfulness of God's blessing and presence.

The "sea" (vv. 23-26) was a reservoir for the temple courtyard, so called because of its largeness, according to Josephus.<sup>120</sup> It had a total capacity of 17,500 gallons (2 Chron. 4:5), but it normally held 11,500 gallons (v. 26). It rested on symbols of strength and service (cf. the priests), and symbols of fertility adorned it (v. 24; cf. 6:18).<sup>121</sup> The 12 oxen may have represented the 12 tribes or Solomon's 12 administrative districts.<sup>122</sup>

---

<sup>112</sup>A. Leo Oppenheim, *Ancient Mesopotamia*, pp. 95-98.

<sup>113</sup>See Allen S. Maller, "Hiram from Tyre," *Journal of Reform Judaism* 29:2 (Spring 1982):41-42.

<sup>114</sup>Volkmar Fritz, "Temple Architecture," *Biblical Archaeology Review* 13:4 (July-August 1987):38-49.

<sup>115</sup>Albright, *Archaeology of . . .*, p. 144.

<sup>116</sup>Idem, "Two Cressets From Marisa and the Pillars of Jachin and Boaz," *Bulletin of the American Schools of Oriental Research* 85 (February 1942):18-27.

<sup>117</sup>Cf. Auld, pp. 52-53.

<sup>118</sup>Gray, p. 175.

<sup>119</sup>Jones, 1:183.

<sup>120</sup>Josephus, *Antiquities of . . .*, 8:3:5.

<sup>121</sup>See Albert Zuidhof, "King Solomon's Molten Sea and (pi)," *Biblical Archaeologist* 45:3 (Summer 1982):179-84.

<sup>122</sup>Jones, 1:184.

The priests evidently used the 10 movable stands (vv. 27-40a) when they butchered sacrificial animals. Each one was six feet square, five and one-half feet high, and held up to 230 gallons of water.

The amount of detail the biblical writer included gives us some appreciation of the external beauty, symmetry, glory, and value of the temple. All of this contributed to the greater glory of Yahweh and helped the Israelites appreciate His greatness.

### **Furnishings inside the temple 7:48-50**

As in the Mosaic tabernacle, the metals used expressed the glory of God. The closer to the ark, the throne of Yahweh, the more valuable was the metal used. Everything inside the temple was gold or gold plated, and outside the temple there was bronze. While the ordinary Israelite did not see the inside of the temple, he or she would have known of its glory. Perhaps this section (vv. 48-50) is shorter than the former one (vv. 13-47) because the majority of the people, who were not priests, did not see these furnishings.

"The candelabra were arranged down the length of the main sanctuary to give light on these tables (Ex. 25:31-40)."<sup>123</sup>

### **David's accessories 7:51**

The priests probably placed the treasures David had collected in the rooms of the structure that surrounded the temple (6:5-6) for use in Israel's worship as needed. The temple, then, became the treasury of Israel in that it housed the nation's greatest treasures.

The writer gave us extensive information about the temple furnishings to increase our awe, not only of the temple itself, but also of Yahweh's greatness. The temple and all it contained reflected the God who abode there.

Perhaps Solomon's greatest contribution to Israel's life was the building of the temple. He glorified Yahweh in the eyes of his own people, and in the eyes of his non-Israelite neighbors, by building a magnificent house for the Lord. The amount of text given to the description of the temple and Solomon's palace complex illustrates the importance of these buildings in ancient Near Eastern culture.

## **5. The temple dedication ch. 8**

This chapter climaxes the writer's emphasis on the greatness of Yahweh as Israel's God. It is the most detailed account of a dedication service in the Bible. It is also one of the most theologically significant texts in 1 and 2 Kings.

### **The entrance of the ark 8:1-11**

The Israelites regarded the ark as the throne of Yahweh. It was the place where He manifested His presence in a localized way and where He received the blood that atoned for the Israelites' sins on the Day of Atonement. The ark had rested in David's tabernacle

---

<sup>123</sup>Wiseman, p. 116.

in Zion since David had brought it from the house of Obed-edom (2 Sam. 6:17). It was the only item in the temple that was not new. Perhaps God did not change it to help the people realize that He, symbolized by the ark, had not changed. His person and methods of dealing with them at the mercy seat were the same as they had been.

The ceremony of installing the ark in Solomon's temple took place during the Feast of Tabernacles. This was one of the feasts that the Mosaic Law specified that all Israelite males had to attend (Lev. 23:33-36). This feast was a commemoration of the Lord's faithfulness during His people's wilderness wanderings. It looked back to their slavery in Egypt and forward to their establishment in the Promised Land. The bringing of the ark into the temple symbolized the fulfillment of that hope. Evidently Solomon waited for this feast in order to celebrate the dedication of the temple, and used the months following the completion of construction to furnish it and to prepare for the celebration.<sup>124</sup>

What verses 3-8 picture is the symbolic enthronement of Yahweh as Israel's King. Israel's God now entered into His house. As mentioned above, the people did not regard the sovereignty of a human king as firmly established until he built a palace for himself. Now they saw the sovereignty of the divine King established over Israel.

Perhaps the poles that carried the ark, and were fastened to the sides of the ark (cf. Exod. 25:15), were oriented so that they ran east and west. They were so long (more than 30 feet long; cf. 6:20) that they evidently extended out of the most holy place ("the inner sanctuary") into "the holy place" (v. 8). Apparently the veil that separated the holy place from the most holy place hid the ark from sight, but not the eastern ends of the poles. They were visible from the holy place, but not from "outside" the temple building. "To this day" (v. 8) shows that the writer wrote this part of Kings before 586 B.C. when the Babylonian army destroyed this temple (cf. 9:13, 21; 10:12, 20; 2 Kings 2:22; 8:22; 10:27; 14:7; 16:6; 17:23, 34).

The ark housed the tablets of the Decalogue (Ten Commandments; Heb. 9:4). The sole presence of the Law in the ark reemphasized the importance of the Israelites submitting to the Mosaic Covenant, which these tablets represented. That obedience would be the key to Israel's success (Josh. 1:8). Formerly a pot of manna, symbolizing God's faithful provision of the needs of His people, and Aaron's rod that budded, symbolizing God's confirmation of the Aaronic priesthood, had rested near the ark in the tabernacle.

The shekinah (from the Hebrew root translated "to dwell") cloud (Exod. 19:9; 24:15-16), symbolic of Yahweh's presence, filled the temple. It had also filled the tabernacle at its dedication (Exod. 40:34-35).<sup>125</sup> The Israelites perceived that their God had come to dwell among them and to bless them with His presence. Even priestly ministry was impossible during this glorious revelation of Yahweh. All that the people could do was worship.

---

<sup>124</sup>Gray, p. 193.

<sup>125</sup>See George R. Berry, "The Glory of Yahweh and the Temple," *Journal of Biblical Literature* 56 (1937):115-17.

Josephus described the cloud as "diffused and temperate,—not such a rough one as we see full of rain in the winter season."<sup>126</sup>

### **Solomon's address to the people 8:12-21**

God previously said He would dwell in the cloudy pillar (Lev. 16:2). Solomon hoped God would now dwell in the temple forever (i.e., from then on).

Solomon emphasized the desire of David's heart to build the temple (vv. 17-18). God raised up Solomon to do that, as He had promised. The temple was a house for the reputation (name) of Yahweh; it made a statement about Him. "Name" occurs 14 times in verses 16-20. The Mosaic Covenant was the basis of Israel's ongoing fellowship with God (v. 21). Solomon demonstrated humility and gratitude in what he said.

"This statement reflects the strong emphasis placed on justice in the theology of the Old Testament. Since God is just, He expects His representatives to be just also. The Temple was to be a place where this was recognized."<sup>127</sup>

### **Solomon's prayer of dedication 8:22-53**

This great prayer centers on the Mosaic Covenant. That is its heart. It is the longest prayer in the Bible. Solomon introduced seven petitions with a backward look emphasizing God's faithfulness (vv. 23-26). He concluded with a forward look stressing God's mercy (vv. 52-53).

Solomon's posture of kneeling with open hands uplifted to heaven (v. 52) symbolized his heart attitude, as posture often does in prayer.<sup>128</sup> He, the earthly king, placed himself in a supplicant's position before the heavenly King, dependent and eager to receive the blessings he requested.

Seven petitions follow a general request that God would hear the prayers of His people (vv. 27-30). In these verses Solomon voiced the truth that Yahweh did not really live on earth but in heaven (v. 27). He did not confuse the symbols of God's presence with God Himself (cf. 1 Sam. 4:3). Solomon referred to himself often as God's servant (vv. 28-39, et al.).

Then he requested that God would grant mercy when His people turned to Him in situations involving violations of the covenant. These included personal sins (vv. 31-32), defeat in battle (vv. 33-34), drought (vv. 35-36), and famine (vv. 37-40). He next asked for God's grace on God-fearing foreigners (vv. 41-43), as well as on the Israelites in battle (vv. 44-45) and after captivity (vv. 46-51; cf. Dan. 6:10). All the calamities

---

<sup>126</sup>Josephus, *Antiquities of . . .*, 8:4:2.

<sup>127</sup>Homer Heater Jr., "A Theology of Samuel and Kings," in *A Biblical Theology of the Old Testament*, p. 128.

<sup>128</sup>See Thomas L. Constable, *Talking to God*, pp. 72, 159-60.

Solomon mentioned in his prayer are curses God promised to send on Israel if she broke the Mosaic Covenant (cf. Lev. 26:16-39; Deut. 28:22, 25, 38, 42, 59; 31:17, 29; 32:24).

As Hannah's prayer (1 Sam. 2:1-10) set the tone for all that followed in 1 and 2 Samuel, so Solomon's prayer here does the same for 1 and 2 Kings. The remainder of 1 and 2 Kings shows how God answered Solomon's prayer. That is why this chapter is so significant theologically. The possibilities that the king mentioned here eventually took place in Israel's history, culminating in the Babylonian Captivity. Later in Israel's history, the writing prophets frequently alluded to conditions that Solomon mentioned in this prayer, that came to pass in the prophets' days because of Israel's sins.

"Solomon's prayer is essential to comprehend the message of the book. The author of the Book of Kings intended for the words of Solomon to be heard at a key point in the relationship between God and His people, that is, at the time the temple in Jerusalem was dedicated. The following words of Solomon's prayer [vv. 47-48] would appeal to the exiles and would be a specific plea for repentance because of the hope of returning to the motherland. This is the essence of the book's message."<sup>129</sup>

### **Solomon's benediction on the people 8:54-61**

This benediction began with a review of God's past faithfulness (v. 56). Solomon then voiced three wishes (vv. 57-59) with an explanation concerning his motive (v. 60). He concluded with a challenge for the future (v. 61). The three desires of Solomon's heart were, first, that God would bless his generation with His divine presence (v. 57). Second, he asked that He would give His people the will to walk in obedience to His covenant (v. 58). Third, he prayed that God would keep Solomon's requests dear to His heart (v. 59). Solomon's final appeal to the people was that they would devote themselves to Yahweh wholeheartedly and express that commitment by obeying His Law (v. 61). Unfortunately Solomon himself failed to do this completely.

### **Solomon's sacrifices 8:62-66**

As a royal priest Solomon led the nation of priests in making an immense sacrifice to Yahweh. The sacrifices were all offerings of worship. The burnt offering represented the dedication of the worshipper's person to God and secured forgiveness. The grain offering pictured the dedication of his work to God. The peace offering expressed the joy that resulted from the fellowship God had made possible with Himself and with the worshipper's fellowman (Lev. 1—3).

The number of offerings seems incredibly large, but contemporary extrabiblical records of other sacrifices that involved thousands of animals are extant. Perhaps the priests made sacrifices at other places outside the temple courtyard. People came from the far Northeast (Hamath) and the extreme Southwest (the Wadi el-Arish) to this feast. Solomon extended the celebration an extra week (v. 65).

---

<sup>129</sup>Gershon Galil, "The Message of the Book of Kings in Relation to Deuteronomy and Jeremiah," *Bibliotheca Sacra* 158:632 (October-December 2001):408.

Verse 66 is very significant because it shows that because of Israel's rededication in this covenant renewal ceremony, King Solomon enjoyed blessing from his people on whom he had brought blessing. The result was joy and gladness of heart for everyone. These are what God had promised in the Mosaic Law as consequences of commitment to His will. God blessed Solomon personally, and he became a channel of blessing to the nation he served because he committed himself to obeying God's Word.

This was the biggest event in Israel, in terms of its theological significance, since God gave Israel the Law at Mount Sinai. Israel was finally in the Promised Land with her God enthroned in a place of great honor. Now Israel was in position to fulfill her calling as a nation in the world as never before in her history (cf. Exod. 19:5-6). The significance of this chapter becomes clearer when we read the Prophets section of the Old Testament. The writing prophets alluded to it often.

#### **D. THE FRUITS OF SOLOMON'S REIGN CHS. 9—11**

The writer next recorded what happened to Solomon and to Israel as a result of the king's provision to exalt the reputation of Yahweh among His people. He narrated God's covenant with Solomon (9:1-9), further evidences of Yahweh's blessing (9:10-28), Solomon's greatness (ch. 10), and Solomon's apostasy (ch. 11).

##### **1. God's covenant with Solomon 9:1-9**

God responded to Solomon's dedication of himself and his nation as He had responded to David (2 Sam. 7) and to Solomon earlier (ch. 3). He offered Solomon continued blessing for continued faithfulness.

First, God promised He would do what Solomon had petitioned in his dedicatory prayer (8:22-53; 9:3). Second, He said He would provide a continuous line of descendants from Solomon to sit on Israel's throne if Solomon would continue to follow God faithfully. The alternative would have been cutting off Solomon's descendants and replacing them with descendants from another branch of David's family (cf. the fate of Eli's house). God maintained Solomon's line because, generally speaking, Solomon remained faithful to the Lord. Third, if Solomon, the subsequent kings, or the people abandoned the Lord's covenant, He would do three things. He would remove the people from their land, abandon the temple, and make Israel a byword instead of a blessing. This, too, God did for Israel, because overall, Israel did not remain faithful.

"The rest of Kings will be preoccupied with the blessing which follows obedience and the curses enacted after any failure to obey. The reference point will be to God's revealed word and the language is that of Deuteronomy."<sup>130</sup>

---

<sup>130</sup>Wiseman, p. 125.

## 2. Further evidences of God's blessing 9:10-28

Somewhat after the mid-point of Solomon's 40-year reign, God was blessing him for his faithfulness. What the writer described in this section took place after Solomon had completed his major building projects in Jerusalem, which took about 20 years.

### **Solomon's gifts to Hiram 9:10-14**

Solomon mortgaged 20 Galilean towns (settlements) bordering Phoenicia to Hiram. This brought the border of Phoenicia farther south. This arrangement compensated Hiram for all the lumber and 9,000 pounds of gold he had sent to Solomon for his building projects. Hiram may have called them Cabul, a word that sounds like the Hebrew word for "good for nothing" (v. 13), because they were not in a productive region. This cheap gift did not contribute to ongoing good relations between Israel and Phoenicia.<sup>131</sup>

"The border villages may have been fortified for defence [*sic*] purposes and seem to have been redeemed later (2 Ch. 8:2), perhaps following successful trade (v. 14) or tribute brought from Sheba (*cf.* 10:10)."<sup>132</sup>

"This episode shows a conniving side of Solomon."<sup>133</sup>

### **Solomon's public works 9:15-19**

Solomon was powerful enough to conscript laborers to build the Millo and a wall around Jerusalem. The Millo (lit. filling) evidently refers to the terraces on the east side of Mt. Zion (*cf.* 2 Sam. 5:9). Solomon enlarged these so they connected the City of David with the temple and palace site. He also expanded the wall that encircled the City of David so it included the temple and palace complex to the north thus doubling the size of the city (v. 15).

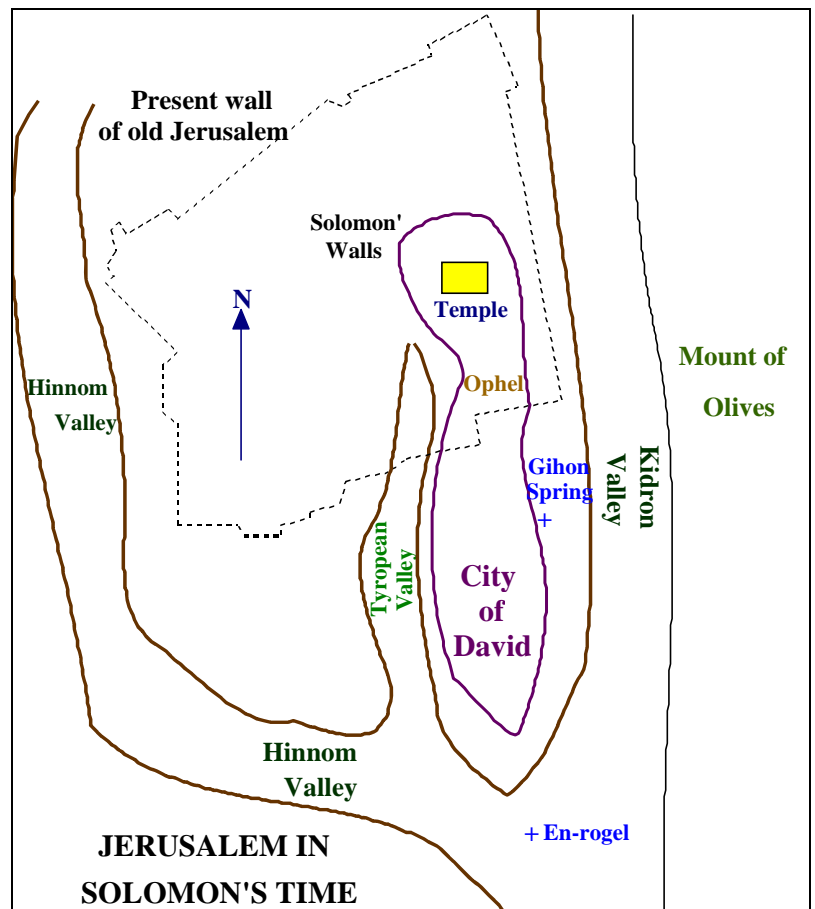

<sup>131</sup>See Josephus, *Against Apion*, 1:18, for his statement that ancient Tyrian records mentioned these things.

<sup>132</sup>Wiseman., p. 126.

<sup>133</sup>House, p. 157.

Solomon also rebuilt and fortified three large strategic defense centers: Hazor in the North (cf. Josh. 11:1), Megiddo in the Jezreel Valley (cf. Josh. 17:11), and Gezer in the West (v. 15). Lower Beth-horon stood on a major western approach route to Jerusalem. He also fortified Baalath (site uncertain) and Tamar, south of the Salt (Dead) Sea, in Judah,<sup>134</sup> and he strengthened other towns (2 Chron. 8:2-6). Solomon developed these towns to defend Jerusalem and Israel and to control the major routes into and through his empire.<sup>135</sup> Were these projects partially flawed by dependence on the flesh? Possibly they were. David had evidently built defensive border cities during his reign as well.<sup>136</sup>

### Solomon's forced labor 9:20-23

Solomon put the defeated native Canaanites to work on government projects (cf. Gen. 9:25-26). Nevertheless this plan proved to be a source of major dissatisfaction in Israel (cf. 12:4). There was a distinction in Solomon's day between Israelites whom the king conscripted for temporary service and non-Israelites who were permanent slave laborers.

The former served as military supervisors over civil forced labor gangs, for example. The latter were the native Canaanites who enjoyed no rights as free persons.<sup>137</sup>

### Solomon's house for Pharaoh's daughter 9:24

Solomon was able to provide lavishly for his Egyptian wife, but he probably should not have married her in the first place (cf. 11:1-2).

### Solomon's annual offerings 9:25

The king offered sacrifices of worship three times annually, probably at the required feasts of Unleavened Bread, Pentecost (also called Harvest or Weeks), and Tabernacles (also called Booths or Ingathering).

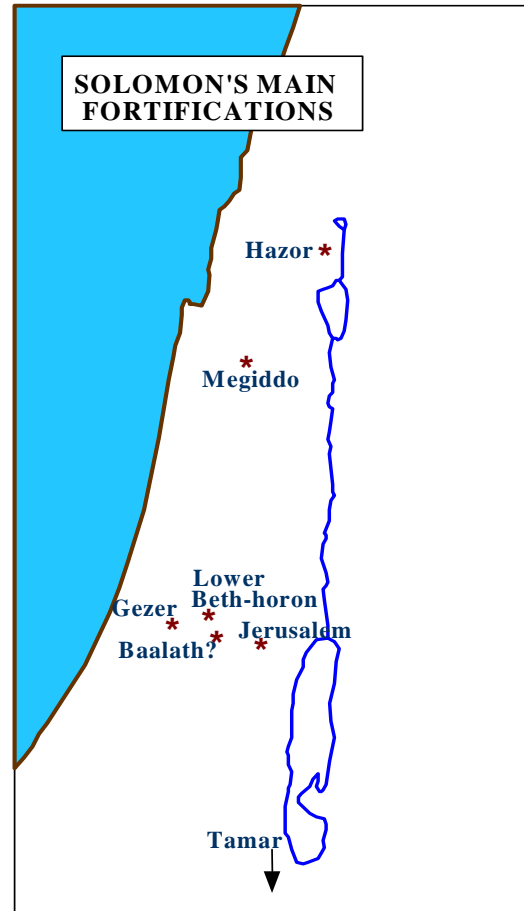

<sup>134</sup>See Rudolph Cohen, "The Fortresses King Solomon Built to Protect His Southern Border," *Biblical Archaeology Review* 11:3 (May-June 1985):56-70; and idem., "Solomon's Negev Defense Line Contained Three Fewer Fortresses," *Biblical Archaeology Review* 12:4 (July-August 1986):40-45.

<sup>135</sup>Bright, p. 192.

<sup>136</sup>Y. Aharoni, "The Building Activities of David and Solomon," *Israel Exploration Journal* 24:1 (1974):13-16.

<sup>137</sup>J. Alberto Soggin, "Compulsory Labor Under David and Solomon," in *Studies in the Period of David and Solomon and Other Essays*, p. 266.



"Solomon officiates at the three major festivals because in ancient Israel the king was a religious as well as a political leader. The king was God's son by adoption (Ps. 2:7), a priest after the order of Melchizedek (Ps. 110:4), and his chief responsibilities were to defend the powerless and to maintain justice, righteousness, and peace (e.g., Ps. 72; Isa. 9:7; 11:2-5)."<sup>138</sup>

"Not only did Solomon show himself a faithful spiritual shepherd by leading His people in worship, but continual attention to prescribed religious duties would keep the temple 'finished,' or properly maintained."<sup>139</sup>

### **Solomon's navy 9:26-28**

God blessed Solomon with an effective navy that brought added wealth from the south and the east.<sup>140</sup> Ophir (v. 28) evidently was in southeast Arabia (modern Oman and or the United Arab Emirates; 10:11; Job 22:24; 28:16). Other less likely sites that various scholars have proposed are southwest Arabia (modern Yemen), Somaliland (Somalia), and Supara in India.

The writer documented in this section further evidence of God's blessing on Solomon that came to him for his dedication to God. The fertility motif stands out strongly here. Blessing in many different forms came to Solomon and Israel.

However, "Solomon's defense works and monumental buildings drained the nation's wealth while providing only a temporary appearance of strength and grandeur [cf. 12:4]."<sup>141</sup>

### **3. Solomon's greatness ch. 10**

This chapter summarizes with illustrations and statistics the wisdom, acceptance, and riches with which God blessed Solomon.

#### **The Queen of Sheba's visit 10:1-13**

The writer seems to have included this event here to support his claim that Solomon's reign was so glorious that rulers came from all over the world to meet him (4:34; cf. 3:16-18). It also shows that some of Solomon's wealth came to him as voluntary gifts from admirers. Jesus used this queen's example to challenge His hearers to listen to God's wisdom through someone greater than Solomon, namely, Himself (Matt. 12:42).

The site of Sheba was about 1,200 miles southeast of Israel (present Yemen and or Oman). A traditional site of the Queen of Sheba's castle is Salalah, in southern Oman.

---

<sup>138</sup>Rice, p. 76.

<sup>139</sup>*The Nelson . . .*, p. 578.

<sup>140</sup>See Finegan, pp. 181-82, for archaeological information about Ezion-geber.

<sup>141</sup>DeVries, p. 133.

Sheba had come to dominate the spice and incense trade that had made that region of Arabia famous.<sup>142</sup> The queen's primary purpose in visiting Solomon seems to have been to make a treaty with him. Before she did so she wanted to make sure that he really was as wise and rich as she had heard. Testing with questions was a challenging activity among ancient Near Eastern monarchs.<sup>143</sup>

"The *hard* ('enigmatic', REB) *questions* (*hidot*) were not just 'riddles', as in Judges 14:12, but included difficult diplomatic and ethical questions. According to Josephus, Hiram had made similar approaches. The test was not an academic exercise but to see if he would be a trustworthy business partner and a reliable ally capable of giving help."<sup>144</sup>

She noted that God had made Solomon a blessing to those around him (v. 8), as God had promised He would do for those who obeyed His covenant. She also blessed Yahweh (v. 9), the God under whom Solomon reigned. Her gifts, which included four and one-half tons of gold, appear to have been part of a covenant treaty she negotiated with Solomon for her country (cf. v. 13). In her visit we see Israel fulfilling its God-given purpose of bringing the Gentiles to Yahweh. The name of this queen in Arabian history is Balkir.

"The royal family of Ethiopia claimed descent from Solomon and the queen of Sheba. It was asserted that the queen gave birth, as a result of her visit, to Menelik I, the traditional founder of the Ethiopian royal line. This is difficult to prove, but it is also difficult to disprove. Though the queen of Sheba did not come from Ethiopia, it is quite clear that Ethiopia was colonized by Sabeans from South Arabia, crossing the Red Sea. Her descendants could have gone to Ethiopia, and Arabic legends give details regarding the queen who married Solomon. It may be added that Josephus speaks of a relationship which the queen of Sheba had with Ethiopia (*Antiq.* II. 10. 2; VI. 5. 6)."<sup>145</sup>

Other scholars are less sure of this connection.<sup>146</sup> Josephus called her the "queen of Egypt and Ethiopia," but that identification is probably incorrect.<sup>147</sup>

### **Solomon's wealth 10:14-29**

This pericope summarizes Solomon's wealth as the previous one summarized his wisdom. God brought much wealth to Solomon, almost 25 tons of gold a year (v. 14), plus many other riches.

<sup>142</sup>G. W. Van Beek, "Frankincense and Myrrh," *Biblical Archaeologist* 23:3 (September 1960):70-95.

<sup>143</sup>See Harry Torcszyner, "The Riddle in the Bible," *Hebrew Union College Annual* 1 (1924):125-49; Gray, p. 241; Gates, p. 321.

<sup>144</sup>Wiseman, p. 129.

<sup>145</sup>Wood, p. 328.

<sup>146</sup>E.g., Patterson and Austel, p. 102; and Rice, p. 81.

<sup>147</sup>Josephus, *Antiquities of . . .*, 8:6:2, 5-6. For a survey of the traditions connected with the Queen of Sheba, see Edward Ullendorff, "The Queen of Sheba," *Bulletin of John Rylands Library* 45:2 (1963):486-504.

"Those who would consider his income of 666 talents (ca. 21.6 tons) of gold exaggeration should compare this with amounts registered in ancient Egypt about this time, 'where gold is like dust in the land' and Osorkon I in his first four years (ca. 924-920 BC) accumulated eighteen tons of gold, to which some of the loot taken by his father Shishak from Jerusalem should be added (cf. 14:25-27). Similar large-scale acquisition and use of gold in temple building is attested from Mesopotamia."<sup>148</sup>

I do not believe we should criticize Solomon simply for being wealthy, since God promised to make him rich (3:13). Neither should we blame a person, who receives a fortune as an outright gift, for having money. It was the accumulation of riches and ornaments to become materially secure and independent that God forbade. To the extent that Solomon did this—and he evidently did it somewhat—he was guilty of violating God's Law.

Solomon served as an international broker. He capitalized on Israel's strategic geographic location as the land bridge that connected three continents: Europe, Asia, and Africa. He made Israel a clearinghouse through which merchandise passed and charged custom taxes as goods entered and left his country.<sup>149</sup> "Traders" probably refers to business people who passed through Israel and "merchants" to those who did business in Israel.<sup>150</sup> Solomon was probably history's most successful Jewish businessman.

The gold shields he hung in the palace armory were evidently for parade use. Gold is a very soft metal and would have been inappropriate for shields that soldiers used for defense in battle (v. 17). Perhaps the 12 lions surrounding Solomon's throne represented Israel's 12 tribes (v. 20). Tarshish (lit. refinery, v. 22; cf. Jonah 1:3) was probably in Spain or Sardinia. Kue (v. 28) was Cilicia (the Apostle Paul's home province) in modern Turkey (cf. Acts 6:9).

God forbade Israel's kings from multiplying chariots (v. 26), the most effective and dreaded military machines of their day (Deut. 17:16). God wanted His people to depend on Him primarily for their protection. Material prosperity and security often lead people to conclude that they have no needs when really our need for God never diminishes. Solomon fell into this trap. Wealth is not sinful in itself, but it does bring temptations with it (cf. James 5:1-6).

Though Solomon experienced great blessings from his faithful God, he fell prey to the sins these blessings make easier, as the writer explained in the next chapter.

#### **4. Solomon's apostasy ch. 11**

The writer brought Solomon's weaknesses and sins, to which he only hinted previously, into the light in this chapter. Solomon had sown some seeds of departure from God and His Word early in his reign. They bore bitter fruit as he grew older.

---

<sup>148</sup>Wiseman, pp. 131-32.

<sup>149</sup>See Carl Rasmussen, "The Economic Importance of Caravan Trade for Solomon's Empire," in *A Tribute to Gleason Archer*, pp. 153-66.

<sup>150</sup>Rice, p. 82.

### Solomon's foreign wives 11:1-8

The writer's condemnation of Solomon in verses 1-2 rests on Deuteronomy 23:3-9 as well as Deuteronomy 7:3-4. The phraseology goes back to 23:3-9 and the motive to 7:3-4 (cf. Exod. 23:31-33; 34:15-16; Ezra 9:1; Neh. 13:26). Solomon's foreign wives were of two categories: Canaanites prohibited in Deuteronomy 7, and women from other nations prohibited in Deuteronomy 23.<sup>151</sup> Furthermore, God specifically forbade the multiplying of wives by Israel's kings (Deut. 17:17). Solomon violated both the letter and the spirit of the Law. Some writers argued that because God gave legislation in the Mosaic Law governing the conduct of polygamous Israelite men (Exod. 21:10; Deut. 21:15), He therefore approved of polygamy. Yet God had made His will concerning monogamy clear from the beginning of human history (Gen. 2:24). Both Jesus (Matt. 19:5; Mark 10:7-8) and Paul (1 Cor. 6:16; Eph. 5:31) reaffirmed monogamy. The legislation cited in Deuteronomy is only one example of many laws that regulated the conduct of disobedient Israelites.

One of the things that we need to learn to do as we read 1 and 2 Kings is to evaluate what was going on in Israel's history in terms of the Mosaic Covenant. The writer helps us do this at points, but we must do it constantly or we may conclude that things are just fine when they are really contrary to God's will and headed for trouble. This is good training for living and ministering, because we need to develop the habit of evaluating all of life, as we observe it, through the lens of God's will as it is revealed in His Word.

Solomon's harem of 700 wives and 300 concubines (secondary wives, not mistresses in the modern sense, v. 3) was the largest of any Israelite king. Concubines were slaves who could have sexual relations with their masters, according to custom. Their children sometimes became equal heirs with the children of free wives. The next largest harem belonged to Solomon's son Rehoboam who had 18 wives and 60 concubines (2 Chron. 11:21). David had 15 wives (2 Sam. 3:2-5; 5:13-16; 11:27; 1 Chron. 3:1-9) and several concubines (2 Sam. 15:16). Apparently only one of David's wives was a foreigner (2 Sam. 3:3; 1 Chron. 3:2).

"The large number resulted from political alliances, sealed by marriage, with neighbouring [*sic*] states: Moab, Ammon and Edom to the east; Sidon, through the treaty with Hiram (5:1), and Syria ('Hittites' and Arameans, 10:22) to the north. . . . These are cited as examples . . ." <sup>152</sup>

Solomon did not abandon Yahweh, but he worshipped the gods of the nations along with Him (syncretism; vv. 4, 6). His sin was that his heart (affections) went after false gods (v. 4). He did not follow Yahweh fully (exclusively, v. 6; cf. Exod. 20:3; Deut. 30:15-20). Solomon was noteworthy for his love for God when he began reigning (3:3), but at the end of his reign, love for women characterized him (v. 1).

<sup>151</sup>See Shaye Cohen, "Solomon and the Daughter of Pharaoh: Intermarriage, Conversion, and the Impurity of Women," *Journal of the Ancient Near Eastern Society* 16-17 (1984-85):23-27.

<sup>152</sup>Wiseman, p. 134.

Ashtoreth was the Canaanite fertility goddess whose worship involved licentious rites and the worship of the stars. Molech worship included human sacrifice, even the sacrifice of children (cf. Lev. 18:21; 20:1-5). Chemosh worship was equally cruel.<sup>153</sup> Solomon at least tolerated idolatrous worship if he did not actively promote it. The mountain east of (lit. before) Jerusalem, to which verse 7 refers, was traditionally south of the Mount of Olives and is elsewhere called "the mount of destruction" (2 Kings 23:13). Since the Mount of Olives is a two-mile-long ridge, it seems best to view the mount of destruction as the southern part of the Mount of Olives. Another name for "the mount of destruction" is "the hill of evil council." Ironically, today a United Nations building stands atop this hill. Evidently Solomon felt compelled to support the pagan worship of his foreign wives whom he had married to secure political alliances. One sin led to others, as often happens.

"In the ancient world polytheists tended to worship the gods of nations who had conquered their armies or at least the gods of countries more powerful than their own. Ironically, Solomon worships the gods of people he has conquered and already controls. What could he possibly gain from such activity? The whole episode makes no sense, just as idolatry itself makes no sense."<sup>154</sup>

### **Solomon's sentence from God 11:9-13**

This was the third time that God gave Solomon a special revelation (cf. 3:5; 9:2). Solomon's sin in going after other gods was the quintessence of covenant infidelity. David had sinned against God deliberately on occasion when tempted (2 Sam. 11), but his heart remained devoted to Yahweh. His sin was not as serious as Solomon's was (cf. Deut. 6:5).

"One of the most puzzling aspects of the life of Solomon was the fact that he, the wisest of all men, could be so foolish, particularly in the last years of his reign. What must be understood is that the very basis, in fact, the essence of biblical wisdom is to fear God (Prov. 1:7). It was precisely when Solomon neglected this principle that he began the slippery slope to folly (1 Kings 11:9)."<sup>155</sup>

The one tribe Solomon's heir would retain was Judah. Judah had absorbed the tribe of Simeon almost entirely by this time, though some Israelites from Simeon had moved north (2 Chron. 15:9; 34:6).

### **Solomon's external adversaries 11:14-25**

Hadad hated Solomon because of Joab's severe treatment of the Edomites. He may have been a relation of Solomon's by marriage. Pharaoh Siamun, of dynasty 21, apparently gave his daughter to Solomon in marriage and his sister-in-law to Hadad (v. 19).

---

<sup>153</sup>See any good Bible Dictionary for more information about these pagan deities.

<sup>154</sup>House, p. 167.

<sup>155</sup>Eugene H. Merrill, "1 Kings," in *The Old Testament Explorer*, p. 257.

"The result of Hadad's opposition was not only that it lost Solomon the full control of a satellite neighbor, but it cut off his southern route for trade. If he maintained his shipping out of Ezion-geber at all, it was probably on a greatly reduced scale, and it is even possible that it stopped entirely before his death."<sup>156</sup>

Rezon also had reason to oppose Solomon (vv. 23-25). The Lord raised up both these men to bring judgment on Solomon (v. 14).

"The result of Rezon's opposition was that it cut off all contact with the satellite countries of the north. Damascus was the key to control over Zobah, Hamath, and the fortified city of Tadmor. With full control gone in Damascus, there was no possibility of maintaining supervision in these other areas."<sup>157</sup>

<b>KINGS OF ARAM IN 1 KINGS</b>		
<b><u>Kings</u></b>	<b><u>Dates</u></b>	<b><u>References</u></b>
<b>Rezon (Hezion)</b>	ca. 940-915 B.C.	1 Kings 11:23, 25; 15:18
<b>Tabrimmon</b>	ca. 915-900 B.C.	1 Kings 15:18
<b>Ben-Hadad I</b>	ca. 900-860 B.C.	1 Kings 15:18, 20
<b>Ben-Hadad II</b>	ca. 860-841 B.C.	1 Kings 20; 2 Kings 6:24; 8:7, 9, 14

### **Solomon's internal adversary 11:26-40**

Jeroboam, who would become the first king of the Northern Kingdom of Israel, was from Ephraim, the most prominent tribe in the North (v. 26).

Part of Benjamin affiliated voluntarily with Judah eventually (v. 32; cf. 12:21; 2 Chron. 11:1, 10; 15:2, 9; Ezra 4:1). Really parts of two tribes joined the kingdom of Judah: Simeon and Benjamin. The reference to 10 northern tribes evidently included the nine remaining tribes plus either Benjamin or Simeon, whichever provided the majority of its tribe to support the Northern Kingdom. This appears to have been Simeon (cf. 2 Chron. 15:9; 34:6). Levi did not figure in either group.

"*Ten* as the number of completeness and totality is placed in contrast with *one*, to indicate that all Israel was to be torn away from the house of David, as is stated in ch. xii. 20 . . ."<sup>158</sup>

<sup>156</sup>Wood, p. 336.

<sup>157</sup>Ibid.

<sup>158</sup>Keil, p. 179.

David's "lamp" (v. 36) refers to his descendant on the throne (cf. 2 Sam. 21:17).<sup>159</sup> The Hebrew noun *nid*, translated "lamp," can also mean "yoke," and that may be a better translation here.<sup>160</sup>

"A yoke naturally symbolizes control and possession (e.g., Genesis 27:40; Exodus 6:6-7; Numbers 25:3; Deuteronomy 28:48; 1 Kings 12:9-14; Isaiah 9:4; Jeremiah 27:2-12; and others), and its use in the five Old Testament passages mentioned above [i.e., Num. 21:30; 1 Kings 11:36; 15:4; 2 Kings 8:19; and 2 Chron. 21:7], particularly the four that refer to David, connotes the fact that David, his descendants, and the ultimate Davidic king after him would all be God's chosen servants, kings by divine decision with a divinely-ordained purpose to their reigns, with a chosen people and promised land to rule over, the final reign being an unending one and by far the best of all, under a perfect, eternal king—the ultimate Davidic king, Jesus Christ, who is perfectly yoked to His people."<sup>161</sup>

God's conditional promise to Jeroboam was similar to His promises to Saul (1 Sam. 13:13), to David (2 Sam. 7:11, 27), and to Solomon (9:4-7). God would afflict the descendants of David (v. 39) until He raised up Messiah, when all Israel would come under His authority, as it had been under David and Solomon's authority.<sup>162</sup> The reference to Shishak king of Egypt (v. 40) is the first to identify a Pharaoh by name in the Bible. Shishak later invaded Jerusalem during Rehoboam's reign (14:25-26).

### **Solomon's death 11:41-43**

The writer of Kings referred to other ancient records (v. 41; cf. 14:19, 29). The Acts of Solomon was the first of these.<sup>163</sup> It is no longer extant. Solomon's long reign of 40 years (971-931 B.C.) ended with the king in decline both spiritually and politically.<sup>164</sup> (Josephus, incorrectly, wrote that he reigned 80 years and died at the age of 94.<sup>165</sup>)

"What is the image of Solomon which emerges from the narrative? He was the divinely chosen descendent (8:20) of a divinely chosen ruler (8:16), reigning in a divinely chosen city (8:44, 48). He was a righteous judge (chap. 3) and an efficient administrator (chap. 4). He ruled extensive

<sup>159</sup>Ibid., p. 181; Gray, p. 297.

<sup>160</sup>Paul D. Hanson, "The Song of Heshbon and David's Nir," *Harvard Theological Review* 6 (July 1068):297-320.

<sup>161</sup>Douglas K. Stuart, "David's 'Lamp' (1 Kings 11:36) and 'a Still Small Voice' (1 Kings 19:12)," *Bibliotheca Sacra* 171:681 (January-March 2014):8-9.

<sup>162</sup>For a good literary analysis of the chiasmic structure of the Jeroboam narrative (11:26—14:20), see Robert L. Cohn, "Literary Techniques in the Jeroboam Narrative," *Zeitschrift für die Alttestamentliche Wissenschaft* 97 (1985):23-35.

<sup>163</sup>J. Liver, "The Book of the Acts of Solomon," *Biblica* 48:1 (1967):75-101.

<sup>164</sup>See Rodger C. Young, "When Did Solomon Die?" *Journal of the Evangelical Theological Society* 46:4 (December 2003):589-603.

<sup>165</sup>Josephus, *Antiquities of . . .*, 8:7:8.

territory and promoted the peace of his realm and the prosperity of his people (4:20-5:8 [4:20-28]). His building projects were on a grand scale, encompassing sanctuary and palace (chap. 6), fortress and store-city (9:15-19). He pursued an active commercial policy and indulged in a conspicuous display of wealth (chap. 10). The key to his success was his divinely endowed wisdom. He was wiser than all men and all came to see and behold and leave their tribute (5:9-14 [4:29-34], chap. 10)."<sup>166</sup>

"Few figures are more difficult to evaluate than Solomon, and that not merely because the records concerning him are neither so full as could be wished nor in chronological order. He was obviously a man of great astuteness who was able to realize to the fullest the economic potentialities of the empire created by David. At the same time, he exhibited in other areas a blindness, not to say a stupidity, that hastened that empire toward disintegration."<sup>167</sup>

"Solomon brought great blessing to the nation as he followed the Lord, but he also set the nation up for great suffering because of his sinful lifestyle, especially as he grew older (chap. 11). Much of the nation's suffering occurred after his death. But his excessive spending, lack of preparation for transition, poor modeling in many areas—all these affected the next generation. Some suffering seems delayed in the normal course of events, and natural consequences sometimes take time to develop."<sup>168</sup>

Solomon, Saul, and David each reigned 40 years. Saul was God's anointed only because the people demanded a king. David and Solomon were God's anointed because the Lord elected them as His sons. Saul never really appreciated his role as Yahweh's servant. David and Solomon both appreciated their servant roles, but Solomon acted as though he appreciated his less than David did his. David had a heart for God that he maintained throughout his lifetime. Solomon also had a heart for God, but he failed to maintain it. Saul's reign was a tragedy, David's was a triumph, and Solomon's was both.

"If he [Solomon] partly escapes Saul's *condemnation*, he quite fails of David's *commendation*."<sup>169</sup>

In the lives of all three men, the writers of Scripture have carefully pointed out how their responses to God's grace and His Law determined their destinies. Because they were the leaders of the nation, what befell them also affected their kingdoms.

The man best qualified to live life successfully, Solomon, chose not to do so. Success in life from God's viewpoint does not come automatically with the gift of wisdom, but when

---

<sup>166</sup>Porten, pp. 113-114.

<sup>167</sup>Bright, p. 190.

<sup>168</sup>Stephen J. Bramer, "Suffering in the Historical Books," in *Why, O God? Suffering and Disability in the Bible and the Church*, p. 106.

<sup>169</sup>Baxter, 2:87.



one applies wisdom to one's life. Spiritual success depends on choices as well as understanding. Solomon's life teaches us to avoid syncretism and to guard our hearts (cf. vv. 4, 6).

## **II. THE DIVIDED KINGDOM 1 KINGS 12—2 KINGS 17**

The second major part of the Book of Kings records the histories of the Northern Kingdom of Israel and the Southern Kingdom of Judah.<sup>170</sup> During this era of 209 years (931-722 B.C.) the two kingdoms experienced differing relations with one another. For 57 years (931-874 B.C.) they were antagonistic (12:1—16:28). Then for the next 33 years (874-841 B.C.) they were allies (1 Kings 16:29—2 Kings 9:29). Then renewed antagonism erupted and continued for the final 119 years (841-722 B.C.; 2 Kings 9:30—17:41).

Throughout this history the writer's purpose continued to be what it had been: to demonstrate that failure to honor the Mosaic Covenant brings ruin and destruction, but obedience brings blessing. This is clear from the material he chose to record. While he gave a basic historical record of the period, he departed often from official matters to record events that have theological and practical significance. He also gave more information about the Northern Kingdom of Israel than he did about the Southern Kingdom of Judah. The reverse emphasis appears in 1 and 2 Chronicles.

"In the books of Kings in general there are some forty instances where a prophet or prophetess plays a part in the narrative or delivers a message from Yahweh."<sup>171</sup>

It is interesting that there were also 40 kings in both kingdoms.

### **A. THE FIRST PERIOD OF ANTAGONISM 12:1—16:28**

After the division of the kingdom, their respective kings were hostile to one another for 57 years.

#### **1. The division of the kingdom 12:1-24**

This section of text contains the account of the split of the United Kingdom into the Northern Kingdom of Israel and the Southern Kingdom of Judah.

---

<sup>170</sup>See the charts "Dates of the Rulers of Israel and Judah" in Edwin R. Thiele, *A Chronology of the Hebrew Kings*, p. 75; "Kings of Judah and Israel and the Preexilic Prophets" in *The Bible Knowledge Commentary: Old Testament*, p. 513; and "Chronology in Kings" in Wiseman, pp. 28-29. See also the map "The Divided Monarchy" in Merrill, *Kingdom of . . .*, p. 317, for the locations of many places referred to in the text.

<sup>171</sup>N. H. Wallace, "The Oracles Against the Israelite Dynasties in 1 and 2 Kings," *Biblica* 67:1 (1986):21.

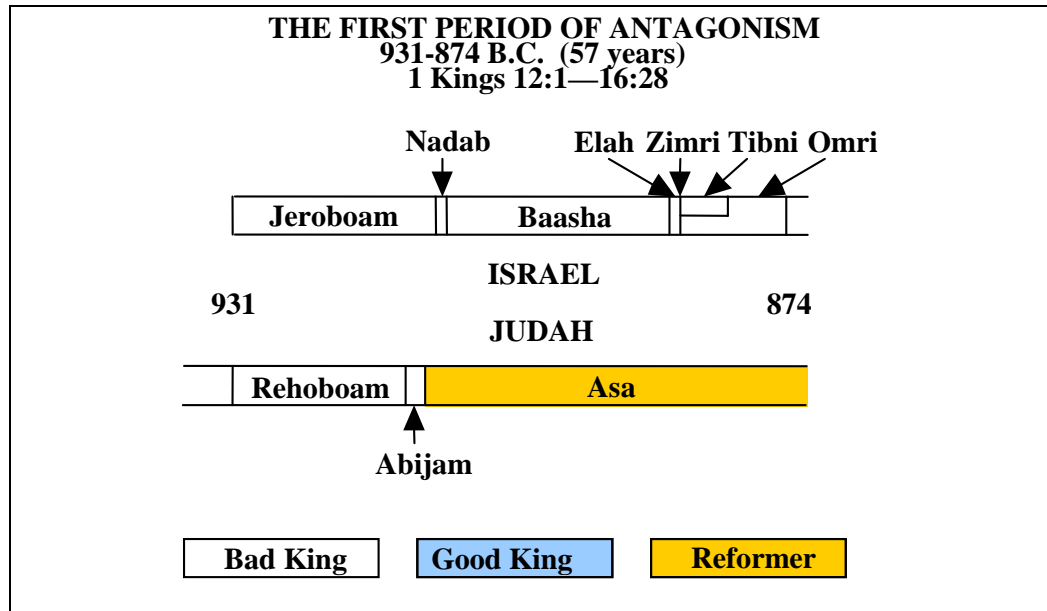

### Rehoboam's dilemma 12:1-5

It is not clear why the northern tribes had invited Rehoboam to the northern town of Shechem. They may have done so for a coronation over Israel separate from his coronation over Judah.<sup>172</sup> On the other hand, the northern tribes may have invited him to go there for his coronation over the entire nation. Jerusalem was the natural coronation site. Perhaps Rehoboam chose to hold the ceremony at Shechem to accommodate, and perhaps placate, the northern tribes. In any case, Shechem was an understandable site because of its historical significance and earlier covenant renewal ceremonies (cf. Gen. 12:6-7; 33:18-20; Josh. 8; 24).

The heavy yoke Solomon had imposed on the Israelites consisted of taxation, forced labor, and other burdens. If Solomon had exempted Judah from these,<sup>173</sup> the spokesmen were probably speaking for the northern tribes rather than for all the Israelites and were demanding similar favors.<sup>174</sup>

### Rehoboam's decision 12:6-15

Rehoboam's name means "The People Are Wide." His choice was whether he would regard himself as the people's servant under Yahweh's authority, as David and Solomon had done, or as the supreme authority in Israel, as Saul had done. His pride led to his downfall. The "scorpion" (v. 11) was a particularly cruel kind of whip that contained sharp pieces of metal (1 Macc. 6:51).

<sup>172</sup>Jacob Myers, *II Chronicles*, p. 65; Bright, p. 210.

<sup>173</sup>See my note on 4:7-19.

<sup>174</sup>Moshe Weinfeld, "The Counsel of the 'Elders' to Rehoboam and Its Implications," *MAARAV* 3:1 (January 1982):27-53.

"Rehoboam chooses slogans over wisdom, machismo over servanthood."<sup>175</sup>

Rehoboam's decision resulted in what God had predicted to Solomon (11:11-13), Ahijah, and Jeroboam (11:31-39).

Many leaders of God's people have repeated Rehoboam's foolish approach to the elders of Israel. Ask, with Solomon, "What is best for the people I serve?" Jesus is our greatest example (cf. Mark 10:45).

### **Israel's secession 12:16-20**

The dissatisfaction with the rule of David's house that had been brewing for years (cf. 2 Sam. 20:1) finally boiled over. Perhaps Rehoboam sent Adoram to pacify the angry mob (v. 18). Whatever his reason, this proved to be "the straw that broke the camel's back."

Rehoboam lacked wisdom because he did not give God the place He deserved in his life. Because he revolted against God, the people revolted against him. In rebelling against Rehoboam, however, the Israelites were rebelling against God's anointed king. That action could only bring divine discipline on them, and it did. This rebellion continued throughout the history of the divided kingdom and accounts for much of the misery that the nation experienced.<sup>176</sup> Rehoboam's coronation turned into a bloody lynching and inspired the coronation of his rival (v. 20).

### **Rehoboam's reprisal 12:21-24**

Rehoboam's pride led him into further trouble. He wanted to start a civil war to recapture the throne. Benjamin joined with Judah at this time and remained allied from then on (cf. 2 Sam. 19:16-17). God had to intervene through a prophet to get Rehoboam to turn back (vv. 22-24). The term "man of God" is synonymous with prophet (cf. 13:18; 2 Kings 5:8; 2 Chron. 12:5).<sup>177</sup> To his credit Rehoboam obeyed God.

"Shemaiah's message goes against the perceived national interest, opposes a popular cause, and stifles the impulse to avenge wounded pride. But Shemaiah was a man of God before he was a man of Judah. His loyalty to God transcended that to king and country. His identity came from his relationship to God, not from society. He served God rather than the state. In short, he was a prophet."<sup>178</sup>

"Rehoboam is harsh, despotic, and autocratic, but the worst part is that he is also stupid and incompetent."<sup>179</sup>

---

<sup>175</sup>R. D. Nelson, *First and Second Kings*, p. 79.

<sup>176</sup>On verse 19, see my comment at 8:8.

<sup>177</sup>See Wiseman, pp. 142-43, for a short note on the term as it appears in Scripture.

<sup>178</sup>Rice, p. 103.

<sup>179</sup>DeVries, p. 159.

There were several reasons for the division of the kingdom. The primary one was Solomon's apostasy. However, tribal jealousy, sectionalism, and Solomon's exploitation of the people were contributing causes.<sup>180</sup>

## **2. Jeroboam's evil reign in Israel 12:25—14:20**

Jeroboam was the first of 20 kings who ruled the Northern Kingdom during its 209-year history. He reigned for 22 years (931-910 B.C.). Not one of the kings of Israel, the Northern Kingdom, turned the people to a serious recommitment to the Mosaic Covenant. Consequently the writer judged all of them evil.

### **Jeroboam's idolatry 12:25-33**

During its history the Northern Kingdom had three capitals: first Shechem (v. 25), later Tirzah (14:17; 15:33), and finally Samaria (16:23-24). Perhaps the king strengthened Penuel in west-central Gilead as a transjordanian provincial center. Like Shechem, Penuel (Peniel) was an important site in patriarchal times (Gen. 32:30). By strengthening these sites, Jeroboam appears to have been trying to get the residents of his kingdom to view their nation as the continuation of what God had begun in patriarchal days. One writer suggested that Jeroboam may have abandoned Shechem and moved to Penuel because Shechem was a divided city. Levitical priests who would have opposed his religious reforms lived there.<sup>181</sup> Jeroboam's fears that his subjects would kill him and return to Rehoboam (v. 27) were due to disbelief in God's promises that the prophet Ahijah had announced to him (11:31, 37-38).

Jeroboam seems to have designed his substitute religious system (vv. 28-33) to offer the Israelites convenient "improvements" in the Mosaic system that tied in with certain events in their history. The golden calves, for instance, recall the golden calf in the wilderness. The apis bull was a common religious symbol in Egypt. The golden calf in the wilderness and these calves may have been similar symbols. There is some question among scholars whether the people regarded calves of this type as idols or as pedestals on which the gods stood.<sup>182</sup> One writer made a good case for their being idols (cf. 14:9).<sup>183</sup> They certainly became idols to the Israelites in the North. However it seems more likely that Jeroboam conceived of them as the symbols and supporters of Yahweh.<sup>184</sup> Archaeologists have discovered the remains of a high place at Dan that they date from the time of Jeroboam I.<sup>185</sup>

<sup>180</sup>Wayne Brindle, "The Causes of the Division of Israel's Kingdom," *Bibliotheca Sacra* 141:563 (July-September 1984):223-33.

<sup>181</sup>Nigel Allen, "Jeroboam and Shechem," *Vetus Testamentum* 24:3 (July 1974):353-57.

<sup>182</sup>William Albright, *Yahweh and the Gods of Canaan*, pp. 197-98; Stephen Von Wyrick, "Israel's Golden Calves," *Biblical Illustrator* 13:1 (Fall 1986):3, 9-12.

<sup>183</sup>John Oswalt, "The Golden Calves and the Egyptian Concept of Deity," *Evangelical Quarterly* 45 (1973):13-20.

<sup>184</sup>See Bright, p. 218; and Merrill, "1 Kings," p. 260.

<sup>185</sup>See Wiseman, p. 144..

"With the division of the kingdom, the chief symbol of God's presence, the ark and the cherubim, was left to Judah. Needing a comparable symbol for his new state, Jeroboam chose the bull, universally admired for its strength and procreative power (Deut. 33:17; Isa. 10:13 [sic]; 34:7; Ps. 68:30; 1 Kings 7:25). It is probable that Jeroboam meant the bull to serve the same function as the ark and cherubim, that is, as the throne or footstool of the invisibly present God.

"The adoption of the bull as a cult object may have been an effort to adapt the ark and cherubim to the culture of the northern tribes, especially since the bull was an indigenous symbol to the Canaanite element of the population. Archaeological finds in Palestine-Syria of statues depicting a god astride a bull point to a function for the bull similar to that of the ark and cherubim (*ANEP [The Ancient Near East in Pictures*, ed. James B. Pritchard], nos. 470-501, 522-538)."<sup>186</sup>

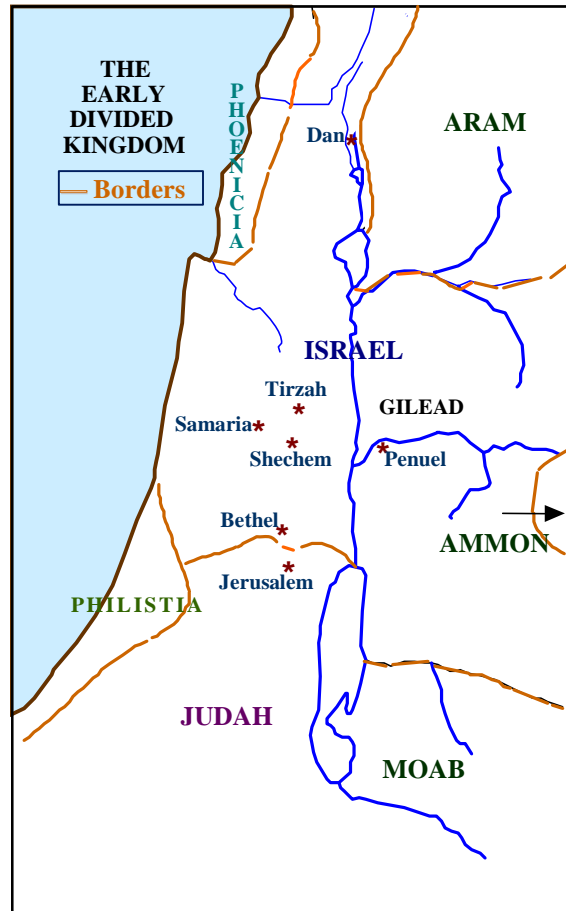

After making the calves, Jeroboam said exactly the same thing Aaron had said (v. 28; cf. Exod. 32:4). This is the first time that the Bible records any deliberate attempt to establish a heterodox cult as the religion of Israel. Jeroboam also followed up the making of the calves with a feast similar to the one at Sinai (vv. 32-33; cf. Exod. 32:5). Furthermore, Jeroboam followed Aaron's example of setting himself up as covenant mediator, in Moses' absence, and as head of the cult (formal worship). In this he was quite clearly identifying his cult with the Exodus.<sup>187</sup> Jeroboam also assumed the role of the Davidic monarch who was the Lord's anointed and, as such, both the political and the religious leader of Israel.<sup>188</sup>

How could Jeroboam have hoped to win the support of the Israelites since he revived the practice of worshipping a calf?

<sup>186</sup>Rice, pp. 106, 107.

<sup>187</sup>Baruch Halpern, "Levitic Participation in the Reform Cult of Jeroboam I," *Journal of Biblical Literature* 95:1 (1976):39-40.

<sup>188</sup>See Gray, pp. 315-18.

"I suggest that the motivation behind Jeroboam's action may have been an intense animosity toward the Levites. It was the Levites who had taken sword in hand to slay the worshippers of Aaron's golden calves. Jeroboam now bypassed the Levites by appointing his own priests and, in a supreme irony, manufactured his own golden calves as a symbol of his disdain for the Levitical priesthood. Had not Moses' own grandson, Jonathan, anticipated Jeroboam by serving as the first priest of the competing shrine at Dan [Judg. 17—18]? Besides according a measure of legitimacy to Dan, this story revealed that even within Moses' family there was room for diversity in religious practice. How could Jeroboam be faulted for his golden calves when Moses' own grandson had officiated over a cult at Dan which worshipped idols having no connection at all with the exodus?"<sup>189</sup>

This may also explain Jeroboam's choice of Dan as one of his cultic centers. But why did he select Bethel? Jacob had met God at Bethel twice (Gen. 28:10-22; 35:1-7). Perhaps Jeroboam promoted it as the birthplace of Israel's faith. Geographically, Bethel stood on the main highway that led into Judah just north of the border. It was a convenient gathering place for Israelites who lived in the southern and central parts of the Northern Kingdom. Since they would have had to pass through Bethel if they wanted to go south to worship in Jerusalem, Jeroboam's priests could have discouraged them from doing so there.

The feast Jeroboam set up (v. 32) took place one month later than the Day of Atonement when the Levitical priests offered sacrifice to atone for the sins of the nation for the past year (Lev. 16). Thus it seems that Jeroboam had no regard for the will of God as expressed in the commands of the Mosaic Covenant. He viewed himself as a king like all the other kings of the ancient Near East. To establish himself and the Northern Kingdom as independent from Judah, he combined commonly accepted religious concepts that the surrounding pagan nations held with elements from Israel's history.<sup>190</sup>

". . . Jeroboam's sins are so far-reaching and repulsive that the author uses him as the example of how to define a morally deficient king (cf. 1 Kgs 16:7, 9 [*sic* 19], 26)."<sup>191</sup>

All of Jeroboam's so-called reforms involved religious apostasy. He set up new objects of worship, new places of worship, new leaders of worship, and new times of worship. These "reforms" proved to be the undoing of the Northern Kingdom. All the kings who followed Jeroboam perpetuated this idolatry.

We need to make sure that the changes we initiate have firm rooting in biblical teaching and do not lead people to depart from it.

---

<sup>189</sup>Merrill, *Kingdom of . . .*, p. 328.

<sup>190</sup>For further discussion, see Eva Danelius, "The Sins of Jeroboam Ben-Nebat," *Jewish Quarterly Review* 58 (1967-68):95-114 and 204-23.

<sup>191</sup>House, p. 178.

(Calvin compared the Roman Catholic Church of his day to the religious system that Jeroboam set up in Israel.<sup>192</sup>)

### **The prophecy of judgment on Jeroboam's religious system 13:1-32**

God sent a young Judahite prophet to Bethel to announce a prophecy that God would judge Jeroboam for his apostasy. (Josephus wrote that his name was Jadon.<sup>193</sup>) Seven times the phrase "by the word of the LORD" appears in this story, emphasizing that this prophet was obeying God by what he said and did (vv. 1, 2, 5, 9, 17,18, 32). When he arrived, the king was exercising his priestly function at the Bethel altar (v. 1).

"Though kings could function as priests in certain circumstances (2 Sam. 6:12-15), it was strictly forbidden for them to offer incense for this was limited to the Aaronic priests alone (Num. 16:39-40; 2 Chron. 26:16-18)."<sup>194</sup>

The prophet predicted Josiah by name 290 years before he became king of Judah (v. 2; cf. Isa. 44:28; 45:1). God fulfilled this prophecy when Josiah destroyed Jeroboam's religious system (2 Kings 23:15-20). The sign God gave was a miracle designed to prove the truthfulness of the prophecy to those who heard it (v. 3). According to the Mosaic Law, the priests were to carefully carry away the ashes from the altar to a clean place for disposal (Lev. 1:16; 4:12; 6:10-11). The pouring out of them there, along with the destruction of this altar, symbolized God's rejection of this sacrificial system. Jeroboam stretched out his hand in a gesture of authority (v. 4). By incapacitating his hand, a symbol of power, God showed He had greater authority than the king and was sovereign over him (v. 4).

We can see that Jeroboam had no regard for Yahweh when he called the Lord the prophet's God rather than his own God (v. 6). By offering the prophet a reward, Jeroboam was seeking to compromise him. If the prophet had gone to Jeroboam's house and accepted his reward, there would have been a question in the minds of onlookers concerning whether he was in Yahweh's service or in Jeroboam's (v. 7). The young man wisely declined even to eat with the king, which in that culture implied mutual affection and protection (v. 8).

The old prophet living in Bethel was a compromiser, as verses 11-32 make clear. If he had been faithful to Yahweh, he might have left Bethel and Israel when Jeroboam brought his nation under a humanly devised system of worship. Many of the faithful in Israel did this (v. 11; cf. 2 Chron. 11:13-17). However, several other faithful prophets lived and ministered in the Northern Kingdom (e.g., Hosea, Jonah, Ahijah, Elijah, Elisha, Micaiah, et al.). The old prophet tried to turn the young prophet away from what God had told him to do (v. 15). He lied about God's revelation to him (v. 18). Like Rehoboam

---

<sup>192</sup>Calvin, 4:2:7-11.

<sup>193</sup>Josephus, *Antiquities of . . .*, 8:8:5.

<sup>194</sup>Merrill, "1 Kings," p. 260.

(12:13) and Jeroboam (12:28), the young man listened to bad counsel rather than obeying a direct word from the Lord.

However, the old prophet did receive some revelations from God (v. 20). He predicted that because the young prophet had not been completely faithful to God, he would have a dishonorable burial (v. 22). A person's burial made a statement about whether his life was honorable or not in the ancient Near East. Since the lion did not eat the prophet or maul his donkey, it was clear that this was an unusual slaying. God had sent the lion to judge the young prophet (v. 24).

"Lions were attested in Palestine until at least the thirteenth century AD."<sup>195</sup>

If God had not judged His own prophet for his disobedience, there might have been some doubt about whether God would judge Jeroboam for his. Perhaps the fact that the biblical writer did not record the young prophet's name implies his disgrace (cf. Ruth 4:1). In spite of his own unfaithfulness, the old prophet admired his young friend and gave him as honorable a burial as was possible (v. 30).

"Perhaps he felt that association with a true prophet of the Lord, even if only in death, would help erase his disobedience in life and ministry."<sup>196</sup>

"This confession [v. 32] proclaims renewal of faith in God's word by the prophet who had become deceitful. The mercy of God is at His disposal! The Lord had healed the hand of Jeroboam (v. 6) because of His mercy, and the Lord restored the faith of the deceitful prophet because of His mercy as well."<sup>197</sup>

"Whatever his motives, and it is impossible to know them for sure, the old man is a mixture of curiosity, dishonesty, accuracy, and conviction."<sup>198</sup>

Again, the absence of his name in the text probably implies that he was a dishonorable person. Josephus described this old man as follows.

"Now there was a certain wicked man in that city, who was a false prophet, whom Jeroboam had in great esteem, but was deceived by him and his flattering words. This man was bed-ridden by reason of the infirmities of old age . . . Whereupon he was afraid that this stranger and prophet should be in better esteem with the king than himself, and obtain greater honour from him . . ."<sup>199</sup>

---

<sup>195</sup>Wiseman, p. 147.

<sup>196</sup>Merrill, "1 Kings," p. 261.

<sup>197</sup>*The Nelson . . .*, p. 586.

<sup>198</sup>Wiseman, p. 189. Cf. W. Gross, "Lying Prophet and Disobedient Man of God in 1 Kings 13: Role Analysis as an Instrument of Theological Interpretation of an OT Narrative Text," *Semeia* 15 (1979):122; and Leon J. Wood, *The Prophets of Israel*, pp. 184-89.

<sup>199</sup>Josephus, *Antiquities of . . .*, 8:9:1.



This incident illustrates the importance of complete obedience to God's Word. God used it to impress this truth on Jeroboam, the Israelites, and all who heard about it, as well as us.

"From beginning to end, the story dwells on a single theme—the fulfillment of the word of the Lord in its due time, having transcended the weakness of its bearer and converted its violators into its confirmants."<sup>200</sup>

The fate of this disobedient prophet anticipated that of Israel.

Disobedience to the Word of God, even on the advice of trusted leadership, leads to divine discipline. We must follow the Lord's Word rather than the counsel of other servants of God, when these conflict. We need to obey God's directives, not what other people say is God's will for us.

### **Jeroboam's continued apostasy 13:33-34**

The prophecy of God's judgment on Jeroboam and its signs (vv. 4-5) did not lead the king to repentance. The most serious aspect of his apostate system was his disregard for what God had required concerning Israel's priesthood (v. 33). By instituting his new priestly system, Jeroboam became responsible for its continuing practice in Israel, which eventually resulted in the Assyrian captivity of Israel (v. 34).

### **The prophecy of judgment on Jeroboam's dynasty 14:1-18**

Whereas the prophecy of the young prophet from Judah dealt with Jeroboam's religious cult, this one predicted the fate of the king's descendants. Compare Samuel's prediction concerning unfaithful Saul's descendants (1 Sam. 13).

"Abijah" means "My Father is the LORD." Jeroboam probably sent his wife to see Ahijah because that prophet had previously given a favorable prophecy to him (11:29-39). He probably hoped his gift (v. 3) would win the prophet's favor as Jeroboam had won the favor of the old prophet of Bethel. Ahijah's ability to recognize the queen should have convinced her that what he said was from the Lord. Yahweh was still the God of Israel (v. 7), even though Jeroboam refused to acknowledge Him as such. David's viewing himself as Yahweh's servant, keeping His commandments, and following Him with all his heart (v. 8), contrast with Jeroboam's views and practices.

Jeroboam was extremely evil (v. 9) because he set up a new cult. In judgment, God would cut off Jeroboam's descendants so he would not have a continuing dynasty. This is what the Lord had done to Eli and Saul for their similar disregard of God. Jeroboam's descendants would not even enjoy burial. Wild animals would eat them, a terrible disgrace in the minds of ancient Semites (v. 11; cf. 16:4; 21:24; Deut. 28:26).<sup>201</sup> The sign

<sup>200</sup>Uriel Simon, "1 Kings 13: A Prophetic Sign—Denial and Persistence," *Hebrew Union College Annual* 47 (1976):115.

<sup>201</sup>Patterson and Austel, p. 123.

that this would happen would be the death of Jeroboam's sick child (v. 12). His death at this time was really a divine blessing in view of what he would have experienced had he lived (v. 13). The king God raised up (v. 14) was Baasha (15:27-29). God compared Jeroboam's Israel to a shaky reed planted in unstable water (v. 15), like the papyrus reeds Jeroboam had seen in Egypt when he lived there. God handed Israel over to captivity eventually, but only temporarily (v. 16).

Evidently Jeroboam had moved his capital from Shechem to Tirzah (modern Tell el-Far'ah), seven miles to the northeast, and was living there (v. 17).<sup>202</sup>

### **Jeroboam's death 14:19-20**

The writer wrote that the reigns of 18 of Israel's 20 kings stood recorded in "The Chronicles of the Kings of Israel" (all except those of Tibni and Hoshea). This document is different from the canonical books of 1 and 2 Chronicles and is not extant.

Jeroboam was a strong leader. He separated Israel from Judah and reigned a long time. Nevertheless his lack of commitment to Yahweh resulted in him and Israel experiencing discipline from the Lord. During his reign, Israel lost control of the area around Damascus that subsequently became an independent Aramean state. Ironically it was this area that produced enemies of Israel for many years. The Philistines also recovered some of their territory and became stronger (cf. 15:27). Moreover Israel appears to have lost control over Moab about this time.<sup>203</sup> Judah, Israel, and Edom invaded Moab right after King Ahab of Israel died (2 Kings 3:21-27). King Abijah of Judah also defeated Jeroboam in battle (2 Chron. 13:13-20). All of these losses are evidences of God's punishment for apostasy.

### **3. Rehoboam's evil reign in Judah 14:21-31**

"The narrator introduces a new format and style at this point that enables him to state the essence of a king's reign with an economy of words. The introduction and conclusion of the account of each reign conform to a fixed pattern with only slight variations. The following information is regularly given in the introduction to the reigns of the kings of Judah: (1) date of beginning of reign, (2) age at beginning of reign (not noted consistently at first), (3) length and place of reign, (4) name of the queen mother, and (5) a theological evaluation. The pattern for the Israelite kings is the same except that their ages and the names of their mothers are not given. The reign of each king, both Judahite and Israelite, is normally concluded in this manner: (1) summary of reign and referral to the royal annals for additional information, (2) notice of death and place of burial, and (3) name of successor."<sup>204</sup>

<sup>202</sup>See "Tirzah: An Early Capital of Israel," *Buried History* 22:1 (March 1986):14-24; and Finegan, pp. 184-85.

<sup>203</sup>See *The Wycliffe Bible Encyclopedia*, 1975 ed., s.v. "Moab, Moabite," by Arnold C. Schultz.

<sup>204</sup>Rice, p. 125. See also Wiseman, pp. 46-52.

Rehoboam succeeded Solomon and reigned over Judah for 17 years (931-913 B.C.). Jerusalem was the only capital the Southern Kingdom ever had. In contrast to Israel's capitals, Jerusalem was God's chosen center for national life politically and religiously (v. 21). Rehoboam permitted the re-establishment of pagan worship as it had existed in Israel before Joshua conquered the land (vv. 23-24).<sup>205</sup> Perhaps the king's Ammonite mother was responsible for some of this.

"Essentially, the religion of Canaan was based on the assumption that the forces of nature are expressions of divine presence and activity and that the only way one could survive and prosper was to identify the gods responsible for each phenomenon and by proper ritual encourage them to bring to bear their respective powers. This is the mythological approach to reality. Ritual involves human enactments, particularly by cultic personnel such as priests, of the activity of the gods as described in the myths."<sup>206</sup>

Asherah (v. 23) was the mother goddess of the Canaanite pantheon. However, the word Asherah (pl. Asherim) also described a cult object: a tree, a grove of trees, or a pole.<sup>207</sup> Eugene Peterson called the Asherim "sex-and-religion shrines."<sup>208</sup>

Judah's strength and wealth began to diminish as a result of Rehoboam's folly. Pharaoh Shishak (Shoshenq I, 945-924 B.C.) was the king who had given Jeroboam refuge (11:40). He was a very powerful and effective ruler.<sup>209</sup> The campaign that brought him into Judah netted him 156 cities in Judah, Israel, Edom, and Philistia.<sup>210</sup> His invasion diminished much of the glory of the temple and of Yahweh (vv. 26-28). Shishak's offensive was the first serious attack against Judah by any foreign power since Saul's days.

Josephus' description of his attacking army seems inflated.

". . . he had one thousand two hundred chariots in number that followed him, and threescore thousand horsemen, and four hundred thousand footmen."<sup>211</sup>

The biblical writer footnoted "The Chronicles of the Kings of Judah" when he wrote of 14 of those kings (v. 29). Again, this document is not our 1 and 2 Chronicles. The war that kept flaring up between Rehoboam and Jeroboam (v. 30) was a consequence of their turning away from Yahweh. Rebellion against God brought war, but submission would have resulted in peace.

<sup>205</sup>See Helmer Ringgren, *Religions of the Ancient Near East*, pp. 158-69.

<sup>206</sup>Merrill, *Kingdom of . . .*, p. 159.

<sup>207</sup>John Day, "Asherah in the Hebrew Bible and Northwest Semitic Literature," *Journal of Biblical Literature* 105:3 (September 1986):385-408.

<sup>208</sup>Eugene H. Peterson, *The Message*, p. 447, et al.

<sup>209</sup>I. E. S. Edwards, "Egypt: From the Twenty-second to the Twenty-fourth Dynasty," in *Cambridge Ancient History* 3:1:539-49.

<sup>210</sup>Benjamin Mazar, "The campaign of Pharaoh Shishak to Palestine," *Vetus Testamentum Supplements* 4 (1957):57-66.

<sup>211</sup>Josephus, *Antiquities of . . .*, 8:10:2.

#### **4. Abijam's evil reign in Judah 15:1-8**

Abijam (or Abijah, lit. my father is Yah[weh]) reigned from 913 to 911 B.C. while Jeroboam ruled over Israel.<sup>212</sup>

"The accession formulae from this reign onwards make cross-references between Judah and Israel. It is not clear whether this was to correlate the sources for the reader or to emphasize the essential unity which should have marked both peoples."<sup>213</sup>

The king's mother was a descendant of "Absalom," a variant spelling of "Abishalom" (v. 2). According to 2 Chronicles 13:2, Maacah was the daughter of Uriel and therefore the granddaughter of Absalom.

"The mothers of the kings of Judah are named to show that the claims to the throne are legitimate."<sup>214</sup>

Abijam continued to tolerate the pagan worship reintroduced to Judah during his father's reign (14:23-24). He experienced chastening from the Lord because his heart did not fully belong to Yahweh (vv. 3, 6; cf. 2 Chron. 13:2-20). God's patience with Abijam was due to His promises to David more than to Abijam's own character (vv. 4-5; cf. 2 Sam. 21:17; 1 Kings 11:36).<sup>215</sup>

#### **5. Asa's good reign in Judah 15:9-24**

Asa was the first of eight kings of Judah whom the writer of Kings judged as good. Four of them were reformers who sought to bring the nation back to the Mosaic Covenant, and Asa was the first of these. The other reformers were Jehoshaphat, Hezekiah, and Josiah. The writer of Chronicles described Asa's reforms more fully in 2 Chronicles 14—16.

#### **Asa's godliness 15:9-15**

"Asa" ("Healer"?) came to power close to the end of Jeroboam's reign over Israel in 910 B.C. Asa reigned from 911-870 B.C., 41 years, an unusually long reign that probably began when he was quite young (cf. 15:2). It was his grandmother (NIV), not his mother (NASB), who bore the name Maacah (cf. 15:2). The queen mother (dowager), not the king's wife, was the first lady in the kingdom.<sup>216</sup>

---

<sup>212</sup>Various charts of the kings, including those referred to previously, visualize their overlapping reigns.

<sup>213</sup>Wiseman, p. 154.

<sup>214</sup>*The Nelson . . .*, p. 589.

<sup>215</sup>For the full biblical accounts of the reigns of these kings, consult the harmonies of Samuel, Kings, and Chronicles listed in the bibliography of these notes. The histories of Israel listed in the bibliography also give this information plus data from extrabiblical sources pertaining to their reigns.

<sup>216</sup>Gray, p. 106.

The rightness of Asa's acts is clear from his removing the pagan worship practices of Rehoboam and Abijam (vv. 12-13; cf. Deut. 9:21). He did away with some of the high places (2 Chron. 14:3), but not all of them (v. 14). However, his heart was true to Yahweh all his days (v. 14), even though he became somewhat self-reliant later in his life (2 Chron. 16:7-10).

### **Asa's victory over Israel 15:16-22**

Antagonism continued between Israel and Judah in Asa's day. Ramah was a border town just north of Judah. Many Israelites were leaving Israel to live in Judah, an indication of God's blessing on the Southern Kingdom (cf. 2 Chron. 11:13-17). Baasha may have been building a Berlin wall type of structure at Ramah. Asa's plan to divert Baasha's attention to Ben-Hadad (ca. 900-860 B.C.) worked. His treaty evidenced some lack of trust in Yahweh (2 Chron. 16:7-9). Asa's strategy was one that God blessed, however, and it enabled him to break down Baasha's fortifications and use their materials to rebuild two towns on Judah's side of the border (v. 22).

"*Tabrimmon* (v. 18) means 'good is Rimmon', the Thunderer-god, a title of Baal."<sup>217</sup>

### **Asa's death 15:23-24**

Asa experienced some personal discipline for his trust in the flesh (v. 23; 2 Chron. 16:12). It may have been because of his ill health (gout?) that Asa's son, Jehoshaphat, became coregent with him late in his reign (873-870 B.C.).<sup>218</sup> McFall believed Jehoshaphat's coregency began in 872 or 871.<sup>219</sup> When Asa died, Ahab was reigning in Israel (874-853 B.C.).

Asa's heart was right with God his whole reign (v. 14), as David's had been. Nevertheless, like David, he also sinned. He experienced personal blessing in the form of a long reign and victory over his enemies because of his commitment to Yahweh. He also became a source of blessing to Judah.

## **6. Nadab's evil reign in Israel 15:25-32**

"Nadab" ("Generous" or "Noble") ruled Israel from 910-909 B.C. Evidently Baasha assassinated him during a battle with the Philistines. Gibbethon stood three miles west of Solomon's stronghold city of Gezer near the border where Israel, Philistia, and Judah met. Baasha not only killed Nadab but also all of Jeroboam's male descendants (v. 29). This was a fulfillment of Ahijah's prophecy that God would cut off Jeroboam's dynasty (14:14).

---

<sup>217</sup>Wiseman, p. 156.

<sup>218</sup>See Edwin R. Thiele, "Coregencies and Overlapping Reigns Among the Hebrew Kings," *Journal of Biblical Literature* 93 (1974):174-200.

<sup>219</sup>McFall, p. 45.

"Nothing is more characteristic of the northern state than its extreme internal instability."<sup>220</sup>

The writer of Kings noted carefully the prophecies of the blessings and curses on the kings because of their obedience or disobedience to Yahweh's authority. This is one of the major motifs in Kings.<sup>221</sup>

### **7. Baasha's evil reign in Israel 15:33—16:7**

Baasha's 24-year reign (909-886 B.C.), which was the third longest of any king of the Northern Kingdom, fell within that of Asa's rule over Judah (911-870 B.C.). The Israelite king who ruled the longest was Jeroboam II (41 years) and the second longest was Jehu (28 years).

Baasha had an outstanding opportunity to lead Israel back to true covenantal worship after he had killed Nadab and terminated Jeroboam's dynasty. However, he chose not to do so. He evidently regarded his elevation from a lowly origin (v. 2) to Israel's throne as an opportunity to fulfill personal ambition rather than to glorify Yahweh. For Baasha's failure, God announced that He would cut off his line as He had Jeroboam's (vv. 3-4; cf. 14:11). God ended Baasha's reign for two primary reasons: his continuation of Jeroboam's cult, and the motive and manner with which he assassinated Nadab (v. 7).

"Besides providing information on Baasha's death, these verses [16:5-7] reemphasize the author's theological approach to history. Three issues deserve mention. First, God's word dictates history, a fact Jehu's prophetic rebuke and prediction divulges. Second, Jeroboam and Baasha are judged unfavorably because they use their God-given political authority to preserve their own position rather than to glorify God among the people. Third, the text stresses cause and effect, not fatalistic determinism. God gives both Jeroboam and Baasha the opportunity to follow the covenant. Baasha eliminates Jeroboam's family, as God said would happen, yet becomes like Jeroboam, which makes him a murderer, not a reformer."<sup>222</sup>

### **8. Elah's evil reign in Israel 16:8-14**

The dynasties that Jeroboam and Baasha established were alike in several respects. Both were only two generations long. The first king in each dynasty reigned for a fairly long time: Jeroboam 22 years and Baasha 24. Assassins who were apparently confidants of the kings trusted terminated both dynasties. Each assassin not only killed the king but also all his male descendants, as was customary. Perhaps the most significant difference is that Baasha, the first assassin, successfully established his own dynasty and ruled for many years. The second, Zimri, could not do so. He committed suicide seven days after he became king.

---

<sup>220</sup>Bright, p. 218.

<sup>221</sup>See Ziony Zevit, "Deuteronomistic Historiography in 1 Kings 12—2 Kings 17 and the Reinvestiture of the Israelian Cult," *Journal for the Study of the Old Testament* 32 (1985):57-73.

<sup>222</sup>House, p. 200.

Elah reigned from 886-885 B.C. His assassin, Zimri, was one of his chariot commanders. As the prophet had foretold (v. 3), Baasha's dynasty ended with Elah's death (v. 11).

### **9. Zimri's evil reign in Israel 16:15-20**

Zimri's seven-day reign in 885 B.C. was the shortest in the history of the Northern Kingdom.

Omri was commander-in-chief of Israel's army. He outranked Zimri. When word of Zimri's assassination of Elah reached the soldiers at Gibbethon (cf. 15:27), they immediately sided with their general and marched back to the capital to claim the throne for Omri. Zimri realized he could not oppose Omri successfully and chose suicide over execution. He also destroyed the palace in the process. It was because of his sins in following Jeroboam's ways that God permitted Zimri to fail in his *coup* and to die (v. 20).

"Out of the chaos portrayed in this section will come Omri, a man who will stabilize the Northern Kingdom, establish a new capital, and begin a new dynasty. His family will rule through 2 Kings 10. They will therefore occupy more of the story than any other northern dynasty. Omrides will also serve as active opponents of the prophets and as patrons of idolatry, especially of Baal worship."<sup>223</sup>

### **10. Omri's evil reign in Israel 16:21-28**

Controversy over who should succeed to Israel's throne raged for six years (885-880 B.C.) in Israel and threatened to consume the nation. Civil war followed Zimri's death (vv. 21-22). Omri finally overpowered Tibni and probably executed him (v. 22). One writer argued that Tibni did not necessarily die but simply passed off the scene.<sup>224</sup> The text seems to contradict this view.

For the last six years of his 12-year reign (880-874 B.C.), Omri reigned from Samaria. This was the new capital he built on a centrally located and easily defended hilltop 12 miles west of Tirzah.<sup>225</sup>

Omri was probably the most capable king Israel had enjoyed since the division of the kingdom. Assyrian records refer to Israel as "the land of Omri."<sup>226</sup> His influence extended far. He defeated the Moabites, the record of which constitutes one of the inscriptions on the famous Moabite Stone. He also made a treaty with Ethbaal, king of Tyre and Sidon (887-856 B.C.), that involved the marriage of his son, Ahab, and Ethbaal's daughter, Jezebel. A granddaughter of Ethbaal, Dido, founded Carthage.<sup>227</sup> Still the writer of Kings

<sup>223</sup>Ibid., p. 199.

<sup>224</sup>J. Max Miller, "So Tibni Died," *Vetus Testamentum* 18 (1968):392-94.

<sup>225</sup>See Finegan, pp. 185-88.

<sup>226</sup>T. C. Mitchell, "Israel and Judah Until the Revolt of Jehu (931-841 B.C.)," in *Cambridge Ancient History*, 3:1:467.

<sup>227</sup>Wiseman, p. 163.

did not mention these strengths, only the fact that he was the worst king Israel had had spiritually (v. 25). He was very bad because he personally followed Jeroboam's cult and caused the people to sin by allowing it to flourish in Israel.

"... Omri, the builder of Samaria and a man of high international fame, is dismissed in eight verses (1 Kgs 16:21-28). Why? Probably because he plays no particularly significant role in Israel's decline. Again, characterization is based largely on its role in plot development, not on how it will or will not satisfy modern historians."<sup>228</sup>

The first period of antagonism between Israel and Judah ended about 874 B.C. when Ahab made a treaty with King Jehoshaphat of Judah.

"Comparing the political histories of the two kingdoms [during this first period of antagonism], one is struck by the turmoil in Israel and the stability in Judah. There were three violent disruptions of government and a civil war in Israel. In Judah, by contrast, the succession was orderly and routine.

"The reasons for the differences are geographical, political, and theological. Judah was relatively isolated, cut off from the coastal plain by the Philistines and from Transjordan by the Dead Sea. Israel, on the other hand, was neighbor to Syria and Phoenicia, and the major thoroughfares of Palestine passed through its territory, linking Israel to the larger biblical world and making it vulnerable to political developments there. Ethnically and culturally Judah was comparatively homogeneous. Israel with its ten tribes and large Canaanite population (Judg. 3:1-5) had a history of tribal rivalries (Judg. 8:1-3; 12:1-6) and had to contend with differing culture patterns. There were also basic differences in the understanding of kingship."<sup>229</sup>

## **B. THE PERIOD OF ALLIANCE 1 KINGS 16:29—2 KINGS 9:29**

King Jehoshaphat of Judah made peace with King Ahab of Israel (22:44). He did so by contracting a marriage between his son, Jehoram, and Ahab's daughter, Athaliah (2 Chron. 18:1). This ended the first period of antagonism between the two kingdoms (931-874 B.C.) and began a 33-year period of alliance (874-841 B.C.).

### **1. Ahab's evil reign in Israel 16:29—22:40**

Ahab ruled Israel from Samaria for 22 years (874-853 B.C.). During the first of these years Asa ruled alone in Judah. Then for three years Asa and Jehoshaphat shared the throne. For the remainder of Ahab's reign Jehoshaphat ruled alone.

---

<sup>228</sup>House, p. 66.

<sup>229</sup>Rice, pp. 130-31.



The writer devoted six chapters to the reign of King Ahab, because many significant things happened in Israel then. Specifically, Ahab tried to establish Baal worship as the official religion of Israel. R. G. Lee described Ahab as "the vile human toad who squatted on the throne," and he described Jezebel as "the beautiful adder coiled beside the toad."<sup>230</sup>

### Ahab's wickedness 16:29-34

Verses 30 and 33 bracket and set forth Ahab's unusual wickedness with special emphasis. The writer had just written that Omri was the worst king so far (v. 25), but now he said Ahab exceeded him in wickedness. For Ahab, the fact that Jeroboam's cult deviated from the Mosaic Law was "trivial" (v. 31).

The writer held Ahab responsible for marrying Jezebel. This was fair because even in arranged marriages in the ancient world the candidates, especially the son, in most cases had the right of refusal. Ahab and Jezebel became the most notorious husband and wife team in Scripture. Jezebel means dunghill. This must have been a name the Israelites gave her. Ahab's greatest sin, however, was that he brought the worship of Baal—the worship of the native Canaanites whom God had commanded Israel to exterminate—under the official protection of his government. Jeroboam had already refashioned Yahweh worship departing from what Moses had prescribed. Ahab went one step further: he officially replaced the worship of Yahweh with idolatry (cf. 18:4). This was a first in Israel's history.

"This represents a quantum leap in the history of apostasy."<sup>231</sup>

The temple and altar to Baal that Ahab erected in Israel's capital symbolized his official approval of this pagan religion. Remember the importance of David bringing the ark into Jerusalem, and Solomon building a temple for Yahweh, and what those acts symbolized.

Verse 34 may at first seem to have no connection with anything in the context. Perhaps the writer included it to show that as God had fulfilled His word about Jericho, so it would be in Ahab's case. Ahab was establishing paganism that God had already said He would judge. Similarly Hiel had tried to set up a city that God had previously said the Israelites should not rebuild (cf. Josh. 6:26). The building of Jericho is also a tribute to Ahab's apostasy since he must have ordered or permitted Hiel to rebuild the city in spite of Joshua's long-standing curse.

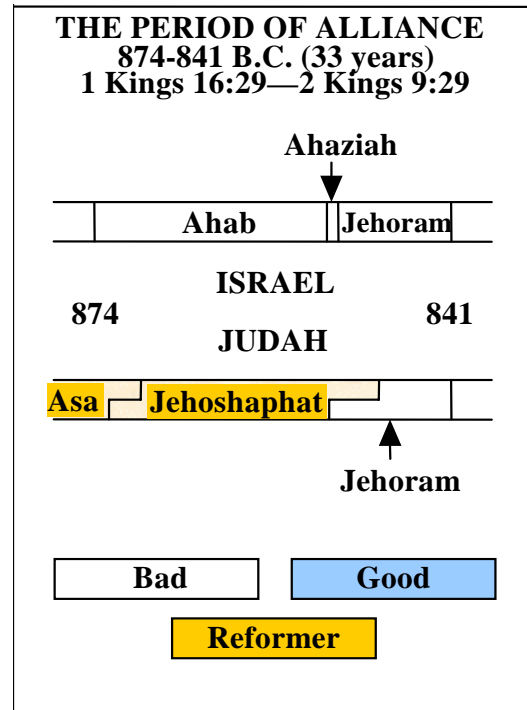

<sup>230</sup>Cited in C. Samuel Storms, *Reaching God's Ear*, p. 216.

<sup>231</sup>Rice, p. 138.

"The foundation sacrifice, revealed by modern archaeology, is probably what was involved. The children named were probably infants, dead or alive, placed in jars and inserted into the masonry, propitiating the gods and warding off evil."<sup>232</sup>

### **Elijah's announcement of God's judgment 17:1-7**

Again God raised up a prophet to announce what He would do. Evidently Ahab's apostasy had been going on for 14 years before God raised up His prophetic challenge.<sup>233</sup> Normally God gives sinners an opportunity to judge themselves and repent before He sends judgment on them (cf. 1 Cor. 11:31; 2 Pet. 3:9-10).

The three scenes in the Elijah narrative (chs. 17—19) form one story in which we can see the rising powers of the prophet. In each succeeding episode of the story he confronted an increasingly difficult problem. In this way God developed his faith and taught the reader the importance of trust and obedience.<sup>234</sup>

". . . cutting across the linear story are parallel patterns which unify the narrative in another way. Specifically, if the narrative is divided into its three major divisions, corresponding basically to the present chapter divisions, one can discern the same sequence of events in each. The corresponding events in each chapter are linked by verbal, thematic, and structural repetitions which create a texture of foreshadows and echoes, of balances and contrasts, of rising and falling action. This parallel patterning gives the narrative a dimension of depth which supports and enriches its linear logic. The following chart outlines the phenomena which we shall proceed to interpret.

"A. Announcement		
by Elijah (17:1)	by God (18:1)	by Jezebel (19:2)
B. Journey		
from Israel (17:2-5)	to Israel (18:2)	from Israel (19:3-4)
C. Two encounters		
ravens (17:6-7)	Obadiah (18:7-16)	an angel (19:5-6)
widow (17:8-16)	Ahab (18:17-20)	the angel of the Lord (19:7)
D. Miracle		
resuscitation (17:17-23)	fire (18:21-38)	theophany (19:9-18)
E. Conversion		
widow (17:24)	Israel (18:39-40)	Elisha (19:19-21)
	Ahab (18:41—19:1)	

<sup>232</sup>DeVries, p. 205.

<sup>233</sup>Merrill, *Kingdom of . . .*, p. 346.

<sup>234</sup>For five helpful, popular messages on incidents in these chapters, see Howard G. Hendricks, *Taking a Stand: What God Can Do through Ordinary You*.

"The parallel elements may be briefly summarized. Each act in the narrative begins with an announcement (A) which initiates the action and, thereby, precipitates a crisis. The announcement propels Elijah to a new locale (B). In the new setting he has two successive encounters or confrontations (C). The second encounter results in a challenge which requires Yahweh's intervention to resolve (D). Finally, in response to this intervention, individuals are 'converted' and declare or exhibit their loyalty to Yahweh (E)."<sup>235</sup>

This dramatic story opens with Elijah bursting onto the scene in Ahab's palace.

"'Before whom I stand' (v. 1) is his claim to authority: it is a technical phrase used of a king's first or 'prime' minister—his confidant and chief executive."<sup>236</sup>

Elijah's name means "Yahweh is my God." He could promise severe drought because God had said this is what He would bring on the land if His people forsook Him (Lev. 26:18-19; Deut. 11:16-17; 28:23-24; 33:28). Josephus quoted the Greek dramatist Menander, who commented on this drought in Menander's account of the activities of Ethbaal, king of the Tyrians.<sup>237</sup>

This drought would have been a challenge to Baal since Baal's devotees credited him with providing rain and fertility. Some representations of Baal that archaeologists have discovered picture him holding a thunderbolt in his hand.

"Why choose a drought? Why emphasize that Yahweh lives? Elijah determines to attack Baalism at its theological center. Baal worshipers believed that their storm god made rain, unless, of course, it was the dry season and he needed to be brought back from the dead. To refute this belief Elijah states that Yahweh is the one who determines when rain falls, that Yahweh lives at all times, and that Yahweh is not afraid to challenge Baal on what his worshipers consider his home ground."<sup>238</sup>

God sent Elijah to Cherith (exact site unknown) to provide for his needs, to hide him from Ahab, and to teach him a lesson (cf. 18:10).<sup>239</sup> Ravens do not even feed their own young (cf. Job 38:41). God provided miraculously for Elijah to build the prophet's faith in view of the conflicts he would face. "Bread" (v. 6) is literally "food" (Heb. *lehem*) and could include berries, fruit, nuts, eggs, etc. Elijah was learning experientially that Yahweh was the only source of food, fertility, and blessing. As God had promised, drought soon began to grip the nation (v. 7).

---

<sup>235</sup>Robert L. Cohn, "The Literary Logic of 1 Kings 17—19," *Journal of Biblical Literature* 101:3 (September 1982):343-44. This article has several good insights into the major motifs and structure of these chapters.

<sup>236</sup>Auld, pp. 109-10.

<sup>237</sup>Josephus, *Antiquities of . . .*, 8:13:2.

<sup>238</sup>House, p. 213.

<sup>239</sup>See the map "Elijah's Travels" in *The Bible Knowledge Commentary: Old Testament*, p. 523.

"It is only our ignorance and neglect of Amos and Hosea that keep us from sensing the heart-shattering tragedy of II Ki. 15:8-31, 17:1-6 in its true proportions. In just under forty years Israel, which had seemed to reach almost Solomonic glory under Jeroboam II (II Kin. 14:25, 28), collapsed into nothingness, like the wooden house whose vitals have been devoured by termites."<sup>240</sup>

<b>MIRACLES INVOLVING ELIJAH<sup>241</sup></b>		
<b>Miracle</b>	<b>Reference</b>	<b>Elements</b>
Elijah fed by ravens	1 Kings 17:6	Water and food
Widow's food multiplied	1 Kings 17:15	Flour and oil
Widow's dead son raised to life	1 Kings 17:22	Life
Elijah's altar and sacrifice consumed	1 Kings 18:38	Water and fire
Ahaziah's 102 soldiers consumed	2 Kings 1:10-12	Fire
Jordan River parted	2 Kings 2:8	Water
Elijah's transport to heaven	2 Kings 2:11	Fire and wind

#### **God's revelation of His power 17:8-24**

God had a very unusual ministry for Elijah to perform in which he would stand alone against hundreds of opponents (18:16-40). This section reveals how the Lord prepared him for it.

The site of Zarephath was between Tyre and Sidon in Phoenicia, the stronghold of the cult that Ahab had imported into Israel (cf. 16:31). Widows were poor in the ancient Near East and would have been the first to run out of food in a drought.<sup>242</sup> Elijah's request for water and then bread (vv. 10-11) evidently identified the widow God had in mind (cf. Gen. 24:10-21). Her response revealed a Gentile believer in Yahweh (v. 12; cf. v. 1; Luke 4:26). Elijah asked the widow to put God's interests—represented by himself, a prophet of Yahweh—before her own as the condition for her blessing (v. 13; cf. Matt. 6:33; Mark 12:41-44). She responded obediently to the word Elijah gave her from God, showing she really believed that Yahweh, not Baal, was the God who could provide food and fertility (v. 14). God honored her faith; He provided her need for food (vv. 15-16).

"In the absence of Baal who lies impotent in the Netherworld, Yahweh steps in to assist the widow and the orphan, and this is even done in the heartland of Baal, Phoenicia."<sup>243</sup>

<sup>240</sup>H. L. Ellison, *The Prophets of Israel*, pp. 44-45.

<sup>241</sup>Adapted from *The Bible Knowledge Commentary: Old Testament*, p. 541.

<sup>242</sup>See Richard D. Patterson, "The Widow, the Orphan, and the Poor in the Old Testament and the Extra-Biblical Literature," *Bibliotheca Sacra* 130:519 (July-September 1973):223-34.

<sup>243</sup>F. C. Fensham, "A Few Observations on the Polarisation between Yahweh and Baal in I Kings 17—19," *Zeitschrift für die Alttestamentliche Wissenschaft* 92:2 (1980):234.

This situation undoubtedly strengthened Elijah's faith in God's power and faithfulness, as well as the faith of the woman.

"The fact that Elijah had to sustain the widow and boy points not only to YHWH as provider for the needy but also as one who 'trained' his prophet, as it were, to be obedient to him. Flour and oil signify life; they are the two common staples in any ancient, as well as modern, Near Eastern household."<sup>244</sup>

The sickness of the widow's son corresponded to Israel's spiritual condition at this time (v. 17). The widow incorrectly blamed herself for her son's predicament (v. 18; cf. John 9:2-3). Elijah realized that only God could bring the boy back to life, so he called on God in prayer to do so (vv. 20-21). Often in cases of miraculous restoration, God's servant placed his hand on the afflicted one. He did so to indicate that the power of God in him was passing to the needy individual (cf. Matt. 8:3). In this instance Elijah placed his whole body against the boy's body for the same reason (v. 21; cf. 2 Kings 4:34; Acts 9:31-43; 20:10). This is the first restoration to life of a dead person that Scripture records. Elijah prayed shamelessly, one of the fundamental requisites for obtaining one's petitions in difficult cases (v. 21; cf. Matt. 7:7-8; Luke 11:5-13). God restored the lad's life (v. 22). In the process Elijah learned the power of God and the power of prayer. He applied both of these lessons in his contest with the Baal prophets (18:16-46). His confidence in his own ability as a channel of God's blessing and word received added strength from the widow's confession (v. 24).

"The best proof of the effectiveness of Elijah's preparation is that he was verified as an authentic man of God and the bearer of God's word by a daughter of the very people he opposed (v. 24)."<sup>245</sup>

If God could raise a dead Gentile boy back to life in response to believing prayer, He could also revive the chosen people of Israel who had become spiritually dead.

". . . the emphasis in this text [17:17-24] is not so much on Elijah as on the word of the Lord which is in Elijah's mouth."<sup>246</sup>

Verses 17-24 display a chiasmic structure that highlights Elijah's control of the situation and his intimate relationship with Yahweh that resulted in the miraculous resuscitation of the boy.

---

<sup>244</sup>James R. Battenfield, "YHWH's Refutation of the Baal Myth through the Actions of Elijah and Elisha," in *Israel's Apostasy and Restoration: Essays in Honor of Roland K. Harrison*, p. 22.

<sup>245</sup>Rice, p. 145.

<sup>246</sup>Marion Soards Jr., "Elijah and the Lord's Word: A Study of I Kings 17:17-24," *Studia Biblica et Theologica* 13:1 (April 1983):39-40.

- "A    'What have you against me, O man of God?'  
       B    'Give me your son!'  
           C    And he took him and brought him up  
               D    And he cried to the Lord and said, 'O Lord  
                   my God.'  
               E    And he stretched upon the boy  
               D'   And he called to the Lord and said, 'O Lord  
                   my God.'  
               E'   And the Lord heard the voice of  
                   Elijah  
               C'   And Elijah took the child and brought him down  
               B'   'See your son lives!'  
 A'    'Now I know that you are a man of God.'"<sup>247</sup>

"The whole point of the story, however, seems to be paramountly a demonstration that YHWH, not Baal, has the power of life over death."<sup>248</sup>

### God's revelation of His people 18:1-16

Elijah would next learn from God how the Israelites would respond to his ministry as God's servant.

Evidently God made the famine especially severe in Samaria (v. 2) because Ahab and Jezebel were the causes of it and lived there. As a believer in Yahweh, Obadiah had been a blessing to 100 of God's prophets even in the famine (vv. 3-4). Surveyors have counted over 2,000 caves in the Mount Carmel area.<sup>249</sup>

When Obadiah met Elijah, he voiced his submission to the man of God and to Yahweh. He did so by calling Elijah his "master" (v. 7). However, Obadiah served two masters. Elijah pointed this out by referring to Ahab as Obadiah's master (v. 8). To rise as high as he had in Ahab's government, Obadiah had to have lived a double life of external support for Ahab while internally following Yahweh.

Obadiah's confession that Yahweh lived presents him as a genuine believer (v. 10). This is exactly the same profession that both the widow (17:12) and Elijah had made (17:1). Obadiah went to great pains to convince Elijah that he was a believer in Yahweh. He must have felt this explanation was necessary because of his position in Ahab's cabinet (v. 13). He obviously struggled with whether he could believe Elijah when the prophet told him he would speak to Ahab (vv. 11-12, 14). Having received a second promise from Elijah that he would not disappear (v. 15), Obadiah finally obeyed the prophet's command (v. 8) and went to Ahab (v. 16).

<sup>247</sup>Cohn, "The Literary . . .," p. 336.

<sup>248</sup>Battenfield, p. 23.

<sup>249</sup>Patterson and Austel, p. 142.

"Why Obadiah should be so featured is, at first, puzzling. Yet the episode appears to have two major purposes. First, Obadiah's speech reveals to Elijah the gravity of the crisis in Samaria during his absence . . .

"Second, through the use of irony, Obadiah's scene establishes the unique authority of Elijah."<sup>250</sup>

Obadiah was similar to many believers in Yahweh who were living in Israel then. They had divided allegiances, their faith in God was weak, they were fearful for their own safety, and they were slow to respond to God's word. What a contrast Obadiah was to the Gentile widow of Zarephath (cf. Matt. 15:21-28)! Elijah saw beforehand, in Obadiah's response to him, how believers in Israel would respond to what he would soon do on Mount Carmel. Elijah would call on the people to do essentially what he had commanded Obadiah to do: obey the Lord's word through His prophet.

### **The vindication of Yahweh 18:17-40**

Ahab had a problem of perception similar to Obadiah's (v. 17; cf. v. 7). The real source of Israel's troubles was Ahab and Omri's disregard of the Mosaic Covenant and their preference for idolatry (Deut. 6:5).

"This was a crime against the state worthy of death (like that of Achan, Jos. 6:18; 7:25; and Jonathan in 1 Sa. 14:24-29)."<sup>251</sup>

Probably hundreds, if not thousands of people, gathered since Elijah summoned all Israel to Mount Carmel. Elijah probably chose this mountain, as God led him, because it stood between Israel and Phoenicia geographically, neutral ground between Yahweh's land and Baal's. Furthermore the Phoenicians regarded Carmel as a sacred dwelling place of Baal. Storms with lightning and thunder were common on Mount Carmel, and Baal worshippers viewed them as manifestations of their deity. The name "Carmel" means "the garden land," and it was famous for its fertility. In the minds of many, Baal had the advantage in this contest. Elijah ordered Ahab around (v. 19), as was appropriate, since the prophet was the representative of the true King of Israel. Surprisingly Ahab obeyed. His weak will becomes even more obvious later in 1 Kings.

"To eat at the table of the king or queen was to be subsidized by the state (cf. 2 Sam. 9:9-11; 1 Kgs. 2:7). So aggressive is Jezebel that she promotes at state expense the worship of Baal and Asherah."<sup>252</sup>

Interestingly, this was a contest of prophets, not priests. The priests had less influence for Yahweh in Israel than the prophets. Apparently the prophets in Phoenicia were more powerful too. Perhaps God accepted Elijah's offering, by a non-priest, because there were no faithful priests in the Northern Kingdom at this time (cf. Num. 18; Deut. 18). The Israelites had been straddling the spiritual fence just as Obadiah had (v. 21).

---

<sup>250</sup>Cohn, "The Literary . . .," pp. 338-39.

<sup>251</sup>Wiseman, p. 168.

<sup>252</sup>Rice, p. 149.

"The issue is not that Israel wanted to reject Yahweh and choose Baal, but rather to serve them both. Elijah called for an either/or decision."<sup>253</sup>

Elijah sought to turn Israel from Baal worship back to Yahweh.

"Here is the Martin Luther of old-time Israel, who singlehandedly challenged the whole priesthood of the state religion, and all the people of the realm, to the decisive test on Mount Carmel."<sup>254</sup>

Elijah realized that he was not the only prophet of Yahweh who remained in Israel (v. 22; cf. v. 13), but in this situation the odds were one against 450. There are several similarities between Judges 4 and 7 and 1 Kings 18. All three encounters with Israel's enemies took place on the south side of the Jezreel Valley. The Kishon figured in both Barak and Elijah's victories over the Canaanites. Gideon faced odds of 450 to one as Elijah did, and both men experienced miraculous deliverances. In the future Israel's enemies will again assemble against her in this valley at Armageddon. Then Jesus Christ will be the hero and will bring an even more spectacular victory to His chosen people (cf. Rev. 16:16; 19:11-21).

Elijah felt alone. His victory would require a supernatural act of God. The oxen as symbols of service may have represented the people of Israel (cf. Num. 7:3). Elijah would sacrifice them as a burnt offering of worship (v. 23). Which "people" would their respective deities accept, those the pagan priests symbolically offered to Baal or those Elijah offered to Yahweh? Aaron had previously conducted a similar test (Lev. 9). The deity who brought fire down would be the true God. By coming in fire, God illustrated His power to judge (Lev. 10:1-2).

Even though Baal worshippers thought the thunder represented Baal's voice, they did not hear his voice on this occasion (v. 26). This was not a rainmaking dance but a wild dance in worship of Baal.<sup>255</sup> Elijah did something that must have shocked everyone present: he mocked Baal. In the ancient East, even if a person did not worship an idol, he at least took its status as a god for granted.<sup>256</sup> However, Elijah refused to acknowledge that Baal was a god at all. He suggested that Baal might be "occupied" (v. 27; lit. relieving himself).<sup>257</sup> His devotees also thought Baal accompanied the Phoenician sailors, so Elijah suggested he might be on a journey (v. 27). All of these possibilities exposed Baal's limited powers. Pagan worship has always proved destructive to humanity, as the priests' cutting themselves illustrated (v. 28). For six hours the priests of Baal ranted and raved to no avail (v. 29).

---

<sup>253</sup>B. S. Childs, *Old Testament Theology in a Canonical Context*, p. 65.

<sup>254</sup>Baxter, pp. 111-12.

<sup>255</sup>Wiseman, p. 169.

<sup>256</sup>Rice, p. 150.

<sup>257</sup>Gray, p. 398; Gary A. Rendsburg, "The Mock of Baal in 1 Kings 18:27," *Catholic Biblical Quarterly* 50:3 (July 1988):415. For other interpretations of this verse, see Leo Hayman, "A Note on I Kings 18:27," *Journal of Near Eastern Studies* 10 (1951):57-58.



Yahweh's altar at that site (one of the high places?) had fallen into disrepair (v. 30). Elijah rebuilt it, as the Mosaic Covenant specified, with 12 uncut stones symbolic of Israel's 12 tribes. There was still only one Lord, one covenant, and one nation with one destiny in the plans and purposes of God, even though the nation had split into two parts.

"As Moses built an altar at Sinai and set up twelve stones for the twelve tribes (Exodus 24:4), and Joshua erected the twelve stones at Gilgal in the Gilgal covenant festival (Joshua 4:3), so Elijah built an altar of twelve stones 'according to the number of the tribes' of Israel (I Kings 17 [sic 18]:31)."<sup>258</sup>

The 12 pitchers of water (vv. 33-34) likewise represented Israel, probably as God's instrument of refreshment to the world. Elijah may have obtained the water from a spring or perhaps from the Great (Mediterranean) Sea that is not far from some parts of Mount Carmel. The traditional site of this confrontation, however, is at the east end of the Carmel range of mountains, far from the sea.

Elijah prayed a simple prayer for God's glory at 3:00 p.m., the time of Israel's sacrifice that illustrated its daily commitment to Yahweh (vv. 36-37).<sup>259</sup> Emphasizing the fact that Yahweh had been Israel's God since patriarchal times, Elijah prayed that the Lord would reveal Himself as Israel's God. He also asked that the people would perceive that He had accepted His servant Elijah's offering that he had presented in harmony with God's Law. The heart of the people needed turning back to God, and Elijah prayed for evidence of that as well (v. 37).

God revealed Himself as He had earlier in Israel's history (Lev. 10:1-2). He accepted the sacrifice of the nation symbolized by the 12 stones, the dust out of which He had created the people, and the 12 pitchers of water (v. 38).<sup>260</sup> The Israelites did turn back to God. They demonstrated their repentance with obedience to the Mosaic Law, and God's prophet, by slaying the false prophets as the Law prescribed (v. 40; cf. Exod. 22:20; Deut. 13:1-18; 17:2-7; 18:20). The Kishon Wadi lay just north of Mount Carmel in the Jezreel Valley below.

Elijah's actions on Mount Carmel were a strong polemic against Canaanite religion.<sup>261</sup>

"The contest on Carmel is not, as often billed, between Elijah and the prophets of Baal: it is between his Lord Yahweh himself and Lord Baal."<sup>262</sup>

<sup>258</sup>Frank Moore Cross, *Canaanite Myth and Hebrew Epic*, p. 192.

<sup>259</sup>Josephus, *Antiquities of . . .*, 14:4:3. Cf. Acts 3:1.

<sup>260</sup>See Charles E. Baukal Jr., "Pyrotechnics on Mount Carmel," *Bibliotheca Sacra* 171:683 (July-September 2014):289-306.

<sup>261</sup>George Saint-Laurent, "Light from Ras Shamra on Elijah's Ordeal upon Mount Carmel," in *Scripture in Context*, pp. 123-39; Leah Bronner, *The Stories of Elijah and Elisha*; Robert B. Chisholm Jr., "The Polemic against Baalism in Israel's Early History and Literature," *Bibliotheca Sacra* 151:603 (July-September 1994):267-68.

<sup>262</sup>Auld, p. 118.

". . . the whole chapter . . . is seen to have a single motive from beginning to end: the bringing of rain, that Yahweh's supremacy may be established in Israel, not by a barren Pyrrhic victory through a supernatural fire-bolt, but by meeting the crying need of His people for water . . ."263

### **The end of the drought 18:41-46**

Evidently thunder accompanied the falling of the fire (lightning?) from heaven (v. 41).<sup>264</sup> Elijah told Ahab, who had personally witnessed the contest, that he could celebrate by eating (v. 41). Perhaps he had been fasting to end the drought. Ahab evidently went up Mount Carmel from the Jezreel Valley below to eat, but Elijah went up higher to pray for rain (v. 42). His posture evidenced humility and mourning as well as prayer.

Rain normally came on Carmel from the west, from the Mediterranean Sea (v. 43). Elijah persisted in prayer, doubtless basing his request on the people's repentance and God's promise to bless that with rain (Deut. 28:12). Perhaps the cloud shaped like a man's hand (v. 44) represented God's hand returning to the land to bless His people again (cf. v. 46). Jezreel (v. 45) was Ahab's winter palace that stood 10 to 20 miles east of Carmel in the Jezreel Valley, depending on where on Mount Carmel these events took place. Perhaps Elijah ran along the ridge of Mount Carmel while Ahab's chariot got bogged down in the muddy valley below (v. 46).

This concludes the account of Israel's three and one-half year drought (17:1—18:46; cf. Luke 4:25; James 5:17; ca. 860-857 B.C.). This drought was a foreview of the three and one-half year Great Tribulation in which God will punish Israel even more severely for her apostasy in the future (cf. Rev. 8—18). The major motifs of this section are Yahweh's superiority over Baal and His faithfulness to withhold blessing (rain) as a punishment and to send it in response to repentance.

"Often in the history of the world great issues have depended on lone individuals, without whom events would have taken a wholly different turn. Yet few crises have been more significant for history than that in which Elijah figured, and in the story of the Transfiguration he rightly stands beside Moses. Without Moses the religion of Yahwehism as it figured in the Old Testament would never have been born. Without Elijah it would have died. The religion from which Judaism, Christianity and Islam all in varying ways stemmed would have succumbed to the religion of Tyre. How different the political history of the world might have been it is vain to speculate. But it is safe to say that from the religion of [Baal] Melkart mankind would never have derived that spiritual influence which came from Moses and Elijah and others who followed in their train."<sup>265</sup>

<sup>263</sup>D. R. Ap-Thomas, "Elijah on Mt. Carmel," *Palestine Exploration Quarterly* 92 (1960):155.

<sup>264</sup>John Ruthven, "A Note on Elijah's 'Fire from Yahweh,'" *Journal of the Evangelical Theological Society* 12:2 (1969):111-15.

<sup>265</sup>H. H. Rowley, "Elijah on Mount Carmel," *Bulletin of the John Rylands Library* 43:1 (September 1960):219. R. P. Carroll, "The Elijah-Elisha Sagas: Some Remarks on Prophetic Succession in Ancient Israel," *Vetus Testamentum* 19:4 (October 1969):408-14, drew attention to the Mosaic parallels and office depicted in the Elijah-Elisha sagas (1 Kings 17—2 Kings 13). See also Ellison, p. 35, for a list of comparisons between Moses and Elijah.

One might compare Moses and Elijah to George Washington and Abraham Lincoln in American history.

"Without question Elijah is one of the most distinctive and diversely talented individuals in the Bible. He is prophet, preacher, political reformer, and miracle worker all at the same time. At the heart of this multifaceted person, though, rests one overriding conviction. Elijah hates Baalism as much as Jezebel loves the cult, and he desires to magnify Yahweh over Baal and defeat the interloping religion once and for all. He makes it his mission to teach that Yahweh lives, that Baal does not exist, and that ethical standards flow from a commitment to the living God."<sup>266</sup>

### **Elijah's disillusionment 19:1-8**

Elijah was surprised that the revival he had just witnessed was not more effective in eliminating Baal worship. Apparently Jezebel's threat drove the lessons of God's power and provision that he had been learning at Cherith, Zarephath, and Carmel out of his memory.

"Probably Elijah had played into Jezebel's hand. Had she really wanted Elijah dead, she surely would have seized him without warning and slain him. What she desired was that Elijah and his God be discredited before the new converts who had aided Elijah by executing the prophets of Baal. Without a leader revolutionary movements usually stumble and fall away. Just when God needed him the most, the divinely trained prophet was to prove a notable failure."<sup>267</sup>

Beersheba was the southernmost sizable town in the Southern Kingdom. Perhaps the fact that Elijah dismissed his servant there and then went farther alone indicates that he was giving up his ministry.<sup>268</sup> Elijah proceeded farther south into the wilderness where the Israelites had wandered for 40 years because of their unbelief. He did not get much refreshment from the natural provisions of the wilderness such as the juniper (broom) tree (v. 4). He said he was no better than his predecessors in purging Israel from idolatry (v. 4), implying that he had expected to see a complete revival. God provided supernaturally for His servant in the wilderness for 40 days and 40 nights, as He had provided for the Israelites for 40 years. Though "the angel of the LORD" sometimes refers to God Himself in the Old Testament (e.g., Exod. 3:2-6), in the books of Kings it probably refers to a human messenger (cf. vv. 5, 7; 2 Kings 1:3; 19:35).

The trip from Beersheba to the traditional site of Horeb (Mount Sinai) took only 14 days by foot. It seems that Elijah was experiencing the same discipline for his weak faith and the same education that God had given the Israelites years earlier. God sustained Elijah faithfully as He had preserved the nation. The Hebrew text has "the" cave rather than "a"

---

<sup>266</sup>House, p. 212.

<sup>267</sup>Patterson and Austel, p. 148.

<sup>268</sup>DeVries, p. 235.

cave (v. 9) suggesting that this may have been the very spot where God had placed Moses before He caused His glory to pass before him (Exod. 33:21-23).

"Elijah's 'pilgrimage' to Sinai was a search for the roots of Yahwism. There Yahweh had appeared to Moses when he was herding sheep, and there He appeared to him when he gave the law. Elijah needed reaffirmation. What he thought he saw happening on Mt. Carmel did not happen, namely, the repentance of Israel. So he went to Mount Sinai (also known as Mount Horeb) to chide Yahweh for forsaking him."<sup>269</sup>

Whereas Moses represented the Law, Elijah represented the prophets in Israel's history.

### **God's revelation of His methods 19:9-21**

Elijah's zeal for God's covenant, altars, and prophets was admirable, but he became too discouraged because he underestimated the extent of commitment to Yahweh that existed in Israel.<sup>270</sup> He was not alone in his stand for Yahweh (v. 10; cf. 18:13). God asked him what he was doing there (vv. 9, 13) because He had not sent him to Horeb, as He had sent him to Cherith, Zarephath, and Samaria (cf. 17:3, 9; 18:1). Elijah had fled to Horeb out of fear. God proceeded to reproduce demonstrations of His power that He had given Israel at Mt. Sinai (Exod. 19:16-18) and to Elijah at Mt. Carmel (18:38, 45). Nevertheless God was not in these in the sense that they were not His methods now. Rather, God was in the gentle blowing (v. 12). Some scholars believe that we should understand the Hebrew words translated "a gentle blowing" (NASB) or "a gentle whisper" (NIV) as "a roaring and thunderous voice" (cf. Exod. 19:16-18; Job 38:1).<sup>271</sup> Though there is good support for it, for some reason this view has not found popular acceptance with most Bible translators.

Moses had spent 40 days and nights on the mountain fasting while he waited for a new phase of his ministry to begin (Exod. 34:28). Jesus spent 40 days and nights in a wilderness at the beginning of His public ministry too (cf. Matt. 4:1-2). Elijah covered his face because he realized that He could not look at God and live (v. 13), as Moses also realized (Exod. 33:20-22; cf. Gen. 32:30). Elijah was to learn that whereas God had revealed Himself in dramatic ways in the past, He would now work in quieter ways. Instead of Elijah continuing to stand alone for God, God would now put him into the background while the Lord used other people.<sup>272</sup> Elijah evidently got the message, but he still felt depressed (v. 14). God was dealing with him gently too.

<sup>269</sup>Heater, p. 134.

<sup>270</sup>Ronald B. Allen, "Elijah the Broken Prophet," *Journal of the Evangelical Theological Society* 22:3 (1979):202.

<sup>271</sup>E.g., J. Lust, "A Gentle Breeze or a Roaring Thunderous Sound?" *Vetus Testamentum* 25:1 (January 1975):115; Stuart, pp. 10-18.

<sup>272</sup>For helpful insights into verses 9-14, see William Dumbrell, "What Are You Doing Here? Elijah at Horeb," *Crux* 22:1 (March 1986):12-19.

"His [Elijah's] God-given successes had fostered an inordinate pride (cf. vv. 4, 10, 14) that had made him take his own importance too seriously. Moreover, Elijah had come to bask in the glow of the spectacular. He may have fully expected that because of what had been accomplished at Mount Carmel, Jezebel would capitulate and pagan worship would come to an end in Israel—all through his influence!"<sup>273</sup>

"I have never been impressed by the view that the command to anoint Hazael, Jehu and Elisha was the expression of God's disapproval of Elijah's flight from Jezebel, and that thereby his prophetic work was as good as terminated. He had a considerable period of activity still before him, and there is absolutely nothing in the story of his departure to justify such a conclusion. For Elijah to anoint those who were to carry on his work, whether he did it personally or by proxy, is rather to stress with what authority they would act, when they brought judgment and destruction on Israel."<sup>274</sup>

Yahweh next directed Elijah to return to Israel to do three things (vv. 15-16). Elijah anointed only Elisha personally (vv. 19-21). He anointed Hazael and Jehu indirectly through his successor, Elisha (2 Kings 8:7-14; 9:1-3). Through these three men, God would complete the purge of Baal worship that Elijah had begun, and bring judgment on the hard-hearted Israelites (v. 17). God also had 7,000 other faithful followers in Israel through whom He could work (v. 18). The writer mentioned some of these loyal people in the chapters that follow. This word from the Lord marks a great crisis in Israel. God now turned from the northern tribes as a whole to deal with a faithful remnant within that nation.<sup>275</sup> Evidence of this is the fact that the stories of Elisha that follow deal mainly with the remnant rather than with the whole nation, in contrast to the record of Elijah's ministry.

Elisha was a prosperous farmer who lived near Abel-meholah (v. 16) in the Jordan Valley, 23 miles south of the Sea of Chinnereth (Galilee). Throwing a prophet's cloak around a person symbolized the passing of the power and authority of the office to that individual.<sup>276</sup> "What have I done to you" (v. 20) is an idiom that means, "Do as you please." Elisha terminated his former occupation and from then on served as a prophet (cf. Amos 7:14-15; Luke 9:62). His sacrifice of his oxen as a burnt offering to Yahweh symbolized his total personal commitment to God (v. 21). Perhaps his 12 pairs of oxen (v. 19) represented the 12 tribes of Israel whom Elisha would now lead spiritually.

"Elijah recruits his attendant and successor at the workplace, as Jesus was to do with many of his followers."<sup>277</sup>

---

<sup>273</sup>Patterson and Austel, p. 148.

<sup>274</sup>Ellison, p. 33.

<sup>275</sup>Ibid., p. 44.

<sup>276</sup>House, p. 225.

<sup>277</sup>Auld, p. 128.

This closes the so-called Elijah cycle or narrative (chs. 17—19), one of the richest portions of the Old Testament for preaching and teaching. In many ways Elijah, Israel's savior, prefigured Jesus Christ and His ministry.

### **God's deliverance of Samaria 20:1-25**

God dealt gently (cf. 19:12) with the Northern Kingdom at this time in the Divided Monarchy to continue to move His people back to Himself. This pericope records the first of three battles the writer recorded in 1 Kings between Ahab and the kings of Aram, Israel's antagonistic neighbor to the northeast. The first of these evidently took place early in Ahab's reign (ca. 874). Ahab's adversary would have been Ben-Hadad I (900-860 B.C.).<sup>278</sup> The political reasons for these encounters were of no interest to the writer of Kings, but we know what they were.<sup>279</sup>

"Taken by themselves, Ben-Hadad's words 'are mine' [v. 3] meant no more than that Israel was a client state to the more powerful Aramean state. Ahab's reply 'All . . . are yours' [or "I am yours, and all that I have," v. 4] would then have been acceptance of such a treaty, in which Israel was the subservient party. [In] '20:5, 6' T[t]he language was no longer that of political formalities; this was a demand for complete surrender of everything of value, of any person of worth, of 'whatever' was 'pleasant' [or "desirable"] in Ahab's eyes, to be handed over to the foreign monarch."<sup>280</sup>

The danger Ben-Hadad posed, as his demands on Ahab continued to escalate, made the Israelite king receptive to the directives of Yahweh's prophet. The prophet presented Yahweh as Israel's real deliverer (v. 13). The deliverance would demonstrate Yahweh's power and superiority over Baal (v. 13). Ahab willingly followed God's orders since he had no other hope (v. 14). God's strategy resulted in victory for Israel (v. 21). The Lord further directed Ahab to prepare for the Aramean army's return the next spring (v. 22). Late spring and early summer were seasons for military expeditions, because at that time of year in the Middle East, grass was readily available for the horses. Victory was certain, though perhaps not known to Ahab, because of the Arameans' limited view of Yahweh's power (vv. 23, 28).

### **God's deliverance of Israel 20:26-30**

The battle of Aphek (873 B.C.) took place on the tableland east of the Sea of Chinnereth (Galilee), the modern Golan Heights. This was not the same Aphek where Saul battled the Philistines (1 Sam. 4:1; 29:1). The Arameans greatly outnumbered Israel (v. 27), but God promised Ahab victory so he and all Israel, as well as the Arameans, would know

<sup>278</sup>See D. D. Luckenbill, "Benhadad and Hadadezer," *American Journal of Semitic Languages* 27 (1911):279; and Julian Morgenstern, "Chronological Data of the Dynasty of Omri," *Journal of Biblical Literature* 59 (1940):392.

<sup>279</sup>See Merrill Unger, *Israel and the Arameans of Damascus*; and Merrill, *Kingdom of . . .*, pp. 346-47.

<sup>280</sup>*The Nelson . . .*, pp. 599-600.

that Yahweh was the true God (v. 28). God enabled the soldiers of Israel to defeat their enemy (v. 29), but He also used supernatural means to assist them (v. 30; cf. Josh. 6; et al.). One hundred casualties a day in ancient warfare was considered heavy,<sup>281</sup> but God gave His people 100 times that number that day.

"The striking parallels to the conquest of Jericho, as the interval of seven days before the battle and the falling of the city walls, clearly identified the battles at Samaria and Aphek as holy war."<sup>282</sup>

### **Ahab's unfaithfulness to Yahweh and his sentence 20:31-34**

This section is similar to the one that recorded Saul's failure to follow Yahweh's command that also resulted in God cutting him off (1 Sam. 13:13-14). The parallels between Saul and Ahab are remarkable throughout this record of Ahab's reign.

Archaeology has confirmed that other ancient Near Eastern kings were more brutal in war than Israel's were (v. 31). Sackcloth and ropes expressed remorse and servitude (vv. 31-32).<sup>283</sup> Ben-Hadad's envoys called their king Ahab's "servant" (v. 32) because that is what Ben-Hadad was willing to become if Ahab would have mercy on him. Ben-Hadad was not Ahab's blood brother (v. 32). Ahab was willing to regard him as such rather than as a servant if Ben-Hadad agreed to make a treaty and concessions to him.

"The term 'brother' was commonly used when relations between kings were cordial (see 9:13). Neb-Hadad might have been implying, 'We are both kings.'"<sup>284</sup>

Ahab's plan was contrary to God's Law that called for the deaths of Israel's enemies (Deut. 20:10-15). Ahab welcomed Ben-Hadad into his chariot (v. 33). This was an honor. The Aramean king was quick to make concessions in return for his life (v. 34). Compare Saul's refusal to execute Agag. The covenant the two men made involved the return of Israelite cities that Aram had previously taken and trade privileges for Israel with Damascus (v. 34). Ahab figured that it would be better for him and Israel to make a treaty than to obey God's Law (cf. Exod. 23:32). Perhaps the reason Ahab was so eager to make this treaty was that the Assyrian Empire was expanding toward Israel from the northeast.

What happened to the man who refused to strike the prophet (vv. 35-36) was exactly what would happen to Ahab and for the same reason, disobedience to the word of the Lord. Compare Samuel's first sentence against Saul for his disobedience (1 Sam. 13). Again a lion was God's agent of execution (cf. 13:24). The prophet's parable recalls the one Nathan told David (2 Sam. 12:1-7). Ahab condemned himself by what he said. God would kill Ahab for not killing Ben-Hadad (22:37). He would also cause Israel, which Ahab headed and represented, to suffer defeat rather than the Arameans (v. 42; cf. 1 Sam.

<sup>281</sup>Wiseman, p. 178.

<sup>282</sup>Rice, p. 172.

<sup>283</sup>See Gray, pp. 429-30.

<sup>284</sup>*The Nelson . . .*, p. 601.

15:22-29). Ahab foolishly chose to follow his own plan instead of obeying the Lord. Obedience probably would have terminated the conflict with the Aramean army.

### **Ahab's disregard for Yahweh's authority 21:1-16**

Even though Jezebel was behind the murder of Naboth, God held her husband Ahab responsible (v. 19). Jezebel's evil influence over her husband stands out in this story.<sup>285</sup> Ahab was willing to murder a godly Israelite to obtain a mere vegetable garden.

"A vineyard, like an olive-orchard, is not just land that may have been in the family for a long time: it represents a high investment in many years of unfruitful care before it reaches maturity."<sup>286</sup>

Naboth sought to live by the Mosaic Law (v. 3; cf. Lev. 25:23-28; Num. 36:7). Ahab's "sullen and vexed" feelings (v. 4; cf. 20:43) were the result of his perception that Naboth's position was unassailable legally. Compare Saul's moodiness following his disobedience and sentence.

Jezebel believed Ahab was the supreme authority in Israel (v. 7), an opinion he shared (cf. 20:42). This was the root of many of Ahab and Jezebel's difficulties (cf. Saul and his daughter Michal, and Ahab and his daughter Athaliah). They failed to acknowledge Yahweh's sovereignty over Israel. Jezebel obviously knew the Mosaic Law (v. 10). It required two witnesses in capital offense cases (Deut. 17:6-7). Cursing God was a capital offense (Lev. 24:16). Jezebel elevated cursing the king to a crime on the same level with cursing Yahweh (v. 10). This was inappropriate but consistent with her concept of Israel's king. She formed her plot in conscious disobedience to God's revealed will.

The elders and nobles of Jezreel were under Jezebel's thumb (v. 11). They were not faithful to Yahweh. They probably could not have been to stay in office under Ahab. Jezebel also executed Naboth's sons (2 Kings 9:26). When Ahab heard what his wife had done, he did not reprove her but took advantage of her actions and in doing so approved them (v. 16). Naboth's vineyard was in Jezreel, not Samaria.<sup>287</sup>

"The most heinous act of Ahab came in the matter of Naboth. A king's primary responsibility was to render justice in the land. Ahab egregiously violated this requirement by stealing from a man he had murdered (through Jezebel)."<sup>288</sup>

Compare Saul's unjustified attempts to kill David.

---

<sup>285</sup>Alexander Rofe, "The Vineyard of Naboth: The Origin and Message of the Story," *Vetus Testamentum* 38:1 (January 1988):102.

<sup>286</sup>Auld, p. 137.

<sup>287</sup>B. D. Napier, "The Omrides of Jezreel," *Vetus Testamentum* 9 (1959):366-78, clarifies the confusing references to Jezreel and Samaria in the Naboth story.

<sup>288</sup>Heater, p. 134.



### **Ahab's judgment for his rebellion against Yahweh 21:17-29**

Again God told Elijah to "go" (v. 18; cf. 17:3, 9; 18:1; 19:15). As a faithful servant, he went to confront the king again. Compare Samuel's second announcement of God's judgment on Saul (1 Sam. 15). Ahab was not in Samaria at this time (v. 18), but in Jezreel (v. 19). The mention of Samaria was evidently an ironical reference to Ahab's capital. Murdering someone and taking possession of his property was a capital offense under the Law of Moses (cf. 2 Sam. 11; 12:13). It would be a great shame for Ahab to have his blood flow in the streets of his winter capital. It would be an even greater disgrace to have it licked up by wild scavengers, as Naboth's blood had been (v. 19; cf. Gal. 6:7). God did not punish him exactly this way because Ahab repented later (vv. 27-29; cf. 2 Kings 9:25-26).

Elijah was Ahab's enemy because the prophet was God's representative whom the king had decided to oppose (v. 20). Ahab had sold himself (v. 20) in that he had sacrificed his own life and future to obtain what he wanted (cf. Saul). The wages God would pay him for this would be trouble and death (cf. Rom. 6:23). God would remove all human support from Ahab and would sweep him away like so much filth (v. 21). The Hebrew word translated "disaster" in verse 21 (*d'h*) is similar to the one translated "evil" in verse 20 (*hd'*). This wordplay emphasizes the correspondence between Ahab's sins and their punishment. God would also cut off Ahab's dynasty for the same reasons He terminated Jeroboam and Baasha's houses (v. 22). As for Jezebel, wild dogs, which normally lived off the garbage in cities, would eat her (v. 23). Furthermore, all of Ahab's descendants would experience ignoble deaths (v. 24; cf. 14:11; 16:4).

The writer's assessment of Ahab was that he was the worst ruler in Israel yet (v. 25; cf. 16:30). He was as bad as the Canaanites whom God drove out because of their wickedness (v. 26; cf. Lev. 18:25-30). Nevertheless he was a king over God's chosen people, though not of the Davidic line. Samson was also very Canaanitish in his thoughts and ways, even though he was a judge in Israel.

Ahab's genuine repentance when he heard of his fate—from Israel's true King—resulted in God's relenting and lightening His sentence (vv. 27-29; cf. Exod. 32:14; Num. 14:12, 20; Ps. 106:44-45; Jer. 18:6-12). Samson also repented (Judg. 16:28). Not Ahab but his son Joram (i.e., Jehoram) would bleed on Naboth's land in Jezreel (v. 19; 2 Kings 9:25-26). There is no indication here or elsewhere that Jezebel ever repented.

"The story of Naboth warns against the use of piety and legality to cloak injustice. It teaches that those who support the plots of a Jezebel, whether by silent acquiescence or overt complicity, share her crime. It is a resounding affirmation that injustice touches God, that 'as you did it to one of the least of these my brethren, you did it to me' (Matt. 25:40, 45), that in the cosmic order of things there is a power at work that makes for justice. And the story attests that there is awesome power in the conscience and protest of the individual servant of God."<sup>289</sup>

---

<sup>289</sup>Rice, p. 181.

### Yahweh's plan to terminate Ahab 22:1-28

Another significant battle occurred between the battle of Ramoth-gilead that the writer recorded in chapter 22 (853 B.C.) and the battles he recorded in chapter 20. Ahab and his Aramean ally Ben-Hadad II (860-841 B.C.) defeated their mutual foe King Shalmaneser III of Assyria at Qarqar on the Orontes River in Aram (also in 853 B.C.).<sup>290</sup> Assyrian records set the date for this battle making it one of the clear benchmarks in Old Testament chronology.<sup>291</sup> The writers of Scripture did not refer to this battle, but a record of it that Shalmaneser wrote has survived and is now in the British Museum.<sup>292</sup> Perhaps it was this victory that encouraged Ahab to challenge his ally at Ramoth-gilead.

King Jehoshaphat of Judah had come to Judah's throne in 873 B.C. and had formed an alliance by marriage with Ahab (2 Chron. 18:1). He had undoubtedly come down from Jerusalem (topographically, and symbolically) to Samaria at Ahab's invitation. Verses 1 and 2 seem to introduce the events in verses 3-40 as they read in the text. However, several years passed between Jehoshaphat's visit in verse 2 and Ahab's invitation to him in verse 4 (cf. 2 Chron. 18:1-2).<sup>293</sup> Evidently the three years of peace mentioned in verse 1 followed the Battle of Aphek (20:26-30; 873 B.C.). Ahab's invitation to Jehoshaphat to join him in battle against the Arameans at Ramoth-gilead (vv. 3-4) must have taken place in 854 or 853 B.C.

Ramoth-gilead had been one of the chief cities in Gad, east of Jezreel about 33 miles, but the Arameans had captured it. Jehoshaphat was a devotee of Yahweh. It was typical of him to inquire concerning the Lord's will (v. 5), though Ahab could not have cared less to do so. The 400 prophets Ahab assembled may have been apostate prophets of Yahweh since Baal prophets would probably have been unacceptable to Jehoshaphat (v. 6; cf. vv. 11, 12, 24). We should therefore interpret Jehoshaphat's request for a prophet of Yahweh (v. 7) as a request for a faithful prophet. Ahab hated Micaiah because he always told the king the truth. Ahab wanted to feel good more than he wanted to know the truth. This is another evidence of Ahab's continuing antagonism toward Yahweh and His representatives (cf. 21:20).

Like Elijah, Micaiah was willing to stand alone for God (v. 14; cf. 18:22). Micaiah had stood before Ahab many times before (v. 8). This time he told the king what he wanted to hear sarcastically (v. 15). Ahab's reply was also sarcastic (v. 16); He had never had to tell Micaiah to speak the truth in Yahweh's name. Micaiah's vision of Israel was of defenseless sheep without a human shepherd, namely, Ahab. They would come home after the battle peacefully (v. 17). The king responded to this prophecy of his death glibly (v. 18). He could not have believed the Lord's word and gone into battle. Saul had done

<sup>290</sup>See Finegan, pp. 204-6; William H. Shea, "A Note on the Date of the Battle of Qarqar," *Journal of Cuneiform Studies* 29 (1977):240-42.

<sup>291</sup>R. K. Harrison, *Introduction to the Old Testament*, p. 733. See the map "The Assyrian Empire" in Merrill, *Kingdom of . . .*, p. 362.

<sup>292</sup>See James Pritchard, ed., *Ancient Near Eastern Texts Relating to the Old Testament*, pp. 278-79, for a translation of it.

<sup>293</sup>Morgenstern, pp. 385-96.

the same thing (1 Sam. 28; 31). Micaiah proceeded to explain that Ahab was the target of God's plan. He would lure him into battle. Still Ahab remained unbelieving. God was Ahab's real enemy, not Aram.<sup>294</sup>

"Foolishly, Ahab thought Elijah and Micaiah were his enemies when, quite the contrary, they were his only links to a future worth living. Today's readers of Scripture have the same option that was offered Ahab: they may hear and repent, or they may sulk and resent the messenger."<sup>295</sup>

Similarly, Saul regarded David as his enemy. The identity of the spirit that stood before the Lord and offered to entice Ahab (v. 21, cf. v. 6) is problematic. This "spirit" may be the personified spirit of prophecy, or it may have been a demon or Satan. Saul also saw a spirit shortly before he died (1 Sam. 28; 31).

". . . God Himself instigated and authorized the deception of Ahab, as indicated by the Lord's initial question to the assembly (22:20), His commission to the spirit (v. 22), and Micaiah's willingness to prophesy a lie after he had vowed to speak only the word of the Lord (vv. 14-15). If the spirit of verses 20-23 can be identified with the divine spirit that energizes prophecy (v. 24), this thesis is further corroborated. The introduction of the truth, rather than ameliorating the deception, shows how effective it was. Even when faced with the truth, Ahab insisted on charging into battle, for the lying spirit working through the prophetic majority had convinced him he would be victorious."<sup>296</sup>

". . . God is truthful in that He keeps His unconditional promises to His people and fulfills His sovereign decrees and oaths. God's commitment to truthfulness, however, does not mean that He never uses deceit as a method of judgment on sinners. But He does so without compromising His truthful character and commitment to righteousness."<sup>297</sup>

Another view is that Satan initiated and superintended demonic activity, which God permitted (cf. 2 Sam. 24:1; 1 Chron. 21:1; Job 1:13-22; 2:7; Zech. 3:1; Matt. 12:24; John 8:44).<sup>298</sup>

Striking on the cheek (v. 24) was a much greater insult then than it is now. Zedekiah was bluffing to the very end. Ahab proved to be hard to the point of insensibility instead of repenting at this prophetic word of judgment, as he had previously done (vv. 26-27; cf. 21:27). Time would tell that Micaiah's words were from the Lord (v. 28).

---

<sup>294</sup>On Micaiah's heavenly vision in verses 19-22, see Allen McNicol, "The Heavenly Sanctuary in Judaism: A Model for Tracing the Origin of an Apocalypse," *Journal of Religious Studies* 13:2 (1987):69-71.

<sup>295</sup>House, p. 249.

<sup>296</sup>Robert B. Chisholm Jr., "Does God Deceive?" *Bibliotheca Sacra* 155:617 (January-March 1998):16-17.

<sup>297</sup>Ibid., p. 12.

<sup>298</sup>See Richard L. Mayhue, "False Prophets and the Deceiving Spirit," *Master's Seminary Journal* 4:2 (Fall 1993):135-63, who evaluated six possible identifications of this spirit. See also Howard, p. 196.

"The comment in verses 25-26 [about Ahab's wickedness] certainly makes Ahab to be the worst of all twenty kings of Israel."<sup>299</sup>

"The king's function was to be immersed in the Law of the Lord and to lead his people in obedience to it (Deut. 17:18-20), not to be leading them in Baal worship (1 Kings 18) or in listening to innumerable false prophets (chap. 22)."<sup>300</sup>

### **Ahab's death 22:29-40**

Ahab probably disguised himself (v. 30) since he was Ben-Hadad's primary target. He had broken their treaty (v. 31). However, his plan to thwart God's will failed. He could not fool or beat Yahweh. One arrow providentially guided was all God needed (v. 34). Josephus wrote, "But Ahab's fate found him out without his robes . . ."<sup>301</sup> Wounded Ahab watched the battle from his chariot until he died that evening (v. 35). Israel lost the battle (v. 36; cf. v. 17). Ahab became the source of much discipline rather than a source of great blessing to Israel because he disregarded God's word and will (cf. Saul).

The fact that the Israelites buried Ahab at all is a tribute to God's grace. All the same, he suffered the ignominy of having the dogs lick his blood, and *that* at the pool where the despised and unclean prostitutes bathed (v. 38). Perhaps this was fitting since he, too, had sold himself.

Ahab was really a capable ruler in spite of his gross spiritual idolatry, which the writer of Kings emphasized. He was generally successful militarily because of the native abilities God had given him and because God showed mercy to Israel. Saul, too, had the potential to be a good king of Israel. Ahab's alliance with Jehoshaphat began the period of peace between Israel and Judah that lasted 33 years. Archaeologists have discovered more than 200 ivory figures, bowls, and plaques in only one storeroom of Ahab's Samaria palace, a tribute to the wealth he enjoyed (cf. v. 39). He also fortified several cities in Israel (v. 39). However, in spite of all his positive contributions, his setting up of Baal worship as the official religion of the nation weakened Israel as never before. His reign took the Northern Kingdom to new depths of depravity. Because he did not acknowledge Yahweh as Israel's King and did not submit to Him, Ahab's personal life ended in tragedy, even a violent death (cf. Saul; 1 Sam. 31). Furthermore, the nation he represented experienced God's chastening instead of His blessing. Agricultural infertility and military defeat marked Ahab's reign as we read of it in 1 Kings.

Here is a summary of some points of comparison between King Ahab and King Saul.

- God gave both kings military victories at first (Ahab's Battle of Aphek, 873 B.C.; 20:1-30).
- Both kings failed to obey God completely by executing their captured enemies (the Amalekites, 1 Sam. 13:13-14; Ben-Hadad, 20:31-34).
- God rejected both kings for their disobedience.

---

<sup>299</sup>Wiseman, p. 184.

<sup>300</sup>Howard, p. 195.

<sup>301</sup>Josephus, *Antiquities of . . .*, 8:15:5.

- Both did not submit to Yahweh's authority. (Saul tried to kill David, and Ahab permitted the murder of Naboth, 21:1-16.)
- Both kings voiced a measure of repentance (21:27-29).
- Both learned they would die in battle but proceeded anyway.
- Both kings disguised themselves before going into battle (Saul did this to the witch; 22:30).
- Both kings died violent deaths in battles with Israel's and Yahweh's enemies (22:35).

The lives of Saul and Ahab reinforce the lessons they teach: submission to Yahweh brings blessing, but proud selfishness leads to destruction. As leaders of God's people, their behavior affected the people they led and resulted in hard times agriculturally, militarily, and spiritually. This is always the case.

## **2. Jehoshaphat's good reign in Judah 22:41-50**

Jehoshaphat began ruling over Judah as coregent with his father Asa (873-870 B.C.). When Asa died, he reigned alone for 17 more years (870-853 B.C.). He concluded his 25-year reign with another period of coregency with his son Jehoram that lasted eight years (853-848 B.C.). For all but Jehoshaphat's first year on Judah's throne, Ahab ruled over Israel. Jehoshaphat became Judah's sole ruler in Ahab's fourth year (v. 41).

Jehoshaphat was one of the eight good kings of Judah and one of the four reforming kings. He was better than his father Asa but not as highly acclaimed by the writers of Scripture as Hezekiah and Josiah, the other reforming kings who followed him years later. Especially in his earlier years Jehoshaphat walked with Yahweh. He removed idolatry from Judah (v. 46) except for the high places (v. 43). Evidently earlier in his reign he removed these (2 Chron. 17:6), but when the people rebuilt them he let them stand (2 Chron. 20:33). The Israelites sometimes used these "high places" in the worship of Yahweh (cf. 3:2-4).

The peace that existed between Israel and Judah (v. 44) gained strength through the marriage of Jehoshaphat's son, Jehoram, and Ahab's daughter, Athaliah (2 Kings 11). A prophet rebuked Jehoshaphat for his alliance with Israel (2 Chron. 19:2).

Edom (v. 47) had been under Judah's control but revolted during Jehoshaphat's reign. It may well have been the Edomites who destroyed his ships at Edom's port of Ezion-geber (v. 48).<sup>302</sup> For Jehoshaphat's other achievements, see 2 Chron. 17—20.

Ahab's ineffective attempts to achieve victory and security for Israel, in unbelief, contrast with Jehoshaphat's trust in God and God's provision of victory for Judah. Jehoshaphat submitted to Yahweh's sovereignty, but he relied on human wisdom and resources at crucial moments in his life. This resulted in mixed blessing and discipline for both himself and Israel.

---

<sup>302</sup>John Bartlett, "The Moabites and Edomites," in *Peoples of Old Testament Times*, p. 236. Cf. Josephus, *Antiquities of . . .*, 9:1:4, which says that his ships were to sail to Pontus and the cities of Thrace.

**3. Ahaziah's evil reign in Israel 1 Kings 22:51—2 Kings 1:18**

A short summary of Ahaziah's two-year term as king (853-852 B.C.) concludes 1 Kings. The events of his reign continue in 2 Kings 1. "Ahaziah" ("Yahweh Has Grasped") was the elder son of Ahab and Jezebel.

This unusual breaking between 1 and 2 Kings was due to the need to divide this long book into two parts, each of which could fit on a standard scroll.

## Appendix 1

### Dates of the Rulers of Judah and Israel

Adapted from Edwin R. Thiele, *A Chronology of the Hebrew Kings*, p. 75.

Judah		Israel	
Rehoboam	930-913	<i>Jeroboam I</i>	930-909
Abijah	913-910	Nadab	909-908
Asa	910-869	<i>Baasha</i>	908-886
Jehoshaphat, coregency with Asa	872-869	Elah	886-885
Jehoshaphat, total reign	872-848	<i>Zimri</i>	885
Jehoram, coregency with Jehoshaphat	853-848	Tibni	885-880
Jehoram, total reign	853-841	<i>Omri</i> , overlap with Tibni	885-874
Ahaziah	841	Ahab	874-853
Athaliah	841-835	Ahaziah	853-852
Jehoash	835-796	Jehoram	852-841
Amaziah	796-767	<i>Jehu</i>	841-814
Azariah, overlap with Amaziah	792-767	Jehoahaz	814-798
Azariah, total reign	792-740	Joash	798-782
Jotham, coregency with Azariah	750-740	Jeroboam II, coregency with Jehoash	793-782
Jotham, official reign	750-732	Jeroboam II, total reign	793-753
Jotham, total years	750-732	Zechariah	753
Ahaz, overlap with Jotham	735-732	<i>Shallum</i>	752
Ahaz, official years	732-715	<i>Menahem</i> , overlap with Pekah	752-742
Hezekiah	715-686	<i>Pekah</i> , overlap with Menahem and Pekahiah	752-732
Manasseh, coregency	697-686	Pekahiah, overlap with Pekah	742-740
Manasseh, total reign	697-642	<i>Hosea</i>	732-723
Amon	642-640		
Josiah	640-609		
Jehoahaz	609		
Jehoiakim	609-598		
Jehoiachin	598-597		
Zedekiah	597-586		

The rulers in italics above began new dynasties.

## Appendix 2

<b>FAITHFUL PROPHETS WHO MINISTERED DURING THE DIVIDED MONARCHY</b>			
<b>Prophet(s)</b>	<b>King(s)</b>	<b>Kingdom(s)</b>	<b>Reference(s)</b>
Ahijah of Shiloh	Jeroboam I	Northern	1 Kings 11:29-39; 12:15; 14:1-18; 15:29; 2 Chron. 9:29; 10:15
Iddo	Jeroboam I Rehoboam? Abijah?	Northern Southern Southern	2 Chron. 9:29 2 Chron. 12:15 2 Chron. 13:22
Shemaiah	Rehoboam	Southern	1 Kings 12:22-24; 2 Chron. 11:2-4; 12:5-8, 15
A man of God from Judah	Jeroboam I	Northern	1 Kings 13:1-10
An old prophet from Bethel	Jeroboam I	Northern	1 Kings 13:11-32
Azariah	Asa	Southern	2 Chron. 15:1-8
Hanani	Asa	Southern	2 Chron. 16:7-10
Jehu ben Hanani	Baasha Jehoshaphat	Northern Southern	1 Kings 16:1-4, 7, 12 2 Chron. 19:1-3; 20:34
Jahaziel	Jehoshaphat	Southern	2 Chron. 20:14-17, 20
Eliezer	Jehoshaphat	Southern	2 Chron. 20:37
Joel	Jehoshaphat or Uzziah (Azariah)	Southern Southern	Joel 1:1
Elijah	Jehoram Ahab  Ahaziah	Southern Northern  Northern	2 Chron. 21:12-15 1 Kings 17:1—19:21; 21:17-24, 28-29 2 Kings 1:3—2:11
100 prophets	Ahab	Northern	1 Kings 18:4, 13
Elisha	Ahab J(eh)oram  Ahaziah Jehoash	Northern Northern  Northern Northern	1 Kings 19:16-21 2 Kings 2:1-25; 3:11-19; 4:1—7:2, 18-20; 8:1-15 2 Kings 9:1-3, 36-37; 10:17 2 Kings 13:14-21
A prophet	Ahab	Northern	1 Kings 20:13-14, 22
A man of God	Ahab	Northern	1 Kings 20:28-29
A son of the prophets	Ahab	Northern	1 Kings 20:35-42
Micaiah ben Imlah	Ahab and Jehoshaphat	Northern Southern	1 Kings 22:7-28; 2 Chron. 18:6-27
50 sons of the prophets from Jericho	J(eh)oram	Northern	2 Kings 2:7-18



A son of the prophets	J(eh)oram	Northern	2 Kings 9:1-10
Obadiah	J(eh)oram or Zedekiah	Northern or Southern	Obad. 1
Zechariah	Joash Uzziah	Southern Southern	2 Chron. 24:20-21 2 Chron. 26:5
A man of God	Amaziah	Southern	2 Chron. 25:7-10
A prophet	Amaziah	Southern	2 Chron. 25:15-16
Jonah	Jeroboam II	Northern	2 Kings 14:25; Jon. 1:1
Amos	Uzziah (Azariah) Jeroboam II	Southern Northern	Amos 1:1 Amos 1:1
Hosea	Uzziah (Azariah) Jotham Ahaz Hezekiah Jeroboam II	Southern Southern Southern Southern Northern	Hos. 1:1-2 Hos. 1:2 Hos. 1:2 Hos. 1:2 Hos. 1:2
Isaiah	Uzziah (Azariah) Jotham Ahaz Hezekiah	Southern Southern Southern Southern	2 Chron. 26:22; Isa. 1:1 Isa. 1:1 Isa. 1:1 2 Kings 19:2-7, 20-34; 19:20-34; 20:1-11, 14-18; 2 Chron. 32:20, 32; Isa. 1:1
Micah	Jotham Ahaz Hezekiah	Southern Southern Southern	Mic. 1:1 Mic. 1:1 Mic. 1:1; Jer. 26:18
Oded	Ahaz	Southern	2 Chron. 28:9-11
Nahum	Manasseh?	Southern	Nah. 1:1
Unnamed prophets	Manasseh	Southern	2 Chron. 33:18
Zephaniah	Josiah	Southern	Zeph. 1:1
Jeremiah	Josiah Jehoahaz Jehoiakim Jehoiachin Zedekiah	Southern Southern Southern Southern Southern	Jer. 1:1-2; 2 Chron. 35:25 (Jer. 1:3) Jer. 1:3 (Jer. 1:3) Jer. 1:3; 2 Chron. 36:11-22
Huldah	Josiah	Southern	2 Kings 22:14-20; 2 Chron. 34:22-28
Habakkuk	Jehoiakim?	Southern	Hab. 1:1
Urijah	Jehoiakim	Southern	Jer. 26:20-23
Daniel	Jehoiakim Jehoiachin Zedekiah	Southern Southern Southern	Dan. 1:1 (Dan. 6:28) (Dan. 6:28)
Ezekiel	Zedekiah	Southern	Ezek. 1:1-3

## Bibliography

- Aharoni, Yohanan. "The Building Activities of David and Solomon." *Israel Exploration Journal* 24:1(1974):13-16.
- Aharoni, Yohanan, and Michael Avi-Yonah. *The Macmillan Bible Atlas*. Revised ed., New York: Macmillan Publishing Co., 1977.
- Albright, William F. *Archaeology and the Religion of Israel*. 5th ed. Baltimore: Johns Hopkins Press, 1968.
- \_\_\_\_\_. *The Archaeology of Palestine*. 1949 Revised ed. Pelican Archaeology series. Harmondsworth, Middlesex, Eng.: Penguin Books, 1956.
- \_\_\_\_\_. "Two Cressets From Marisa and the Pillars of Jachin and Boaz." *Bulletin of the American Schools of Oriental Research* 85 (February 1942):18-27.
- \_\_\_\_\_. *Yahweh and the Gods of Canaan*. Garden City, N.Y.: Doubleday, 1969.
- Allen, Nigel. "Jeroboam and Shechem." *Vetus Testamentum* 24:3(July1974):353-57.
- Allen, Ronald B. "Elijah the Broken Prophet." *Journal of the Evangelical Theological Society* 22:3(1979):193-202.
- Andersen, Francis I. "The Socio-Juridical Background of the Naboth incident." *Journal of Biblical Literature* 85(1966):46-57.
- "Annotated Bibliography on I Kings." *Biblical Viewpoint* 17:1 (April 1973):57-63.
- Ap-Thomas, D. R. "Elijah on Mount Carmel." *Palestine Exploration Quarterly* 92(1960):146-55.
- Archer, Gleason L., Jr. "Old Testament History and Recent Archaeology From Solomon to Zedekiah." *Bibliotheca Sacra* 127:507 (July-September 1970):195-211.
- \_\_\_\_\_. *A Survey of Old Testament Introduction*. Revised ed. Chicago: Moody Press, 1974.
- Auld, A. Graeme. *I & II Kings*. Daily Study Bible Series. Philadelphia: Westminster Press, 1986.
- \_\_\_\_\_. "Prophets and Prophecy in Jeremiah and Kings." *Zeitschrift für die Alttestamentliche Wissenschaft* 96:1(1984):66-82.
- B., J. G. *Short Meditations on Elisha*. New York: Loizeaux Brothers, n.d.
- Ball, E. "The Co-Regency of David and Solomon (1 Kings 1). *Vetus Testamentum* 27:3 (July 1977):268-79.
- Bartlett, John R. "The Moabites and Edomites." In *Peoples of Old Testament Times*, pp. 229-258. Edited by D. J. Wiseman. Oxford: Clarendon Press, 1973.

- Battenfield, James R. "YHWH's Refutation of the Baal Myth through the Actions of Elijah and Elisha." In *Israel's Apostasy and Restoration: Essays in Honor of Roland K. Harrison*, pp. 19-37. Edited by Avraham Gileadi. Grand Rapids: Baker Book House, 1988.
- Baukal, Charles E., Jr. "Pyrotechnics on Mount Carmel." *Bibliotheca Sacra* 171:683 (July-September 2014):289-306.
- Baxter, J. Sidlow. *Explore the Book*. 6 vols. London: Marshall, Morgan, and Scott, n.d.; reprint ed., 6 vols. in 1, Grand Rapids: Zondervan Publishing House, 1966.
- Berlin, Adele. "Characterization in Biblical Narrative: David's Wives." *Journal for the Study of the Old Testament* 23 (July 1982):69-85.
- Berry, George Ricker. "The Glory of Yahweh and the Temple." *Journal of Biblical Literature* 56(1937):115-17.
- Bramer, Stephen J. "Suffering in the Historical Books." In *Why, O God? Suffering and Disability in the Bible and the Church*, pp. 99-109. Edited by Larry J. Waters and Roy B. Zuck. Wheaton: Crossway, 2011.
- Bright, John A. *A History of Israel*. Philadelphia: Westminster Press, 1959.
- Brindle, Wayne A. "The Causes of the Division of Israel's Kingdom." *Bibliotheca Sacra* 141:563 (July-September 1984):223-33.
- Bronner, Leah. *The Stories of Elijah and Elisha*. Leiden, Netherlands: E. J. Brill, 1968.
- Burney, C. F. *Judges and Kings*. Reprint ed. New York: KTAV Publishing House, 1970.
- Bury, J. B.; S. A. Cook; and F. E. Adcock, eds. *The Cambridge Ancient History*. 12 vols. 2nd ed. reprinted. Cambridge, Eng.: University Press, 1928.
- Calvin, John. *Institutes of the Christian Religion*. The Library of Christian Classics series, volumes 20 and 21. Edited by John T. McNeill. Translated by Ford Lewis Battles. Philadelphia: Westminster Press, 1960.
- Carroll, R. P. "The Elijah-Elisha Sagas: Some Remarks on Prophetic Succession in Ancient Israel." *Vetus Testamentum* 19:4 (October 1969):408-14.
- Childs, Brevard S. *Old Testament Theology in a Canonical Context*. Philadelphia: Fortress Press, 1986.
- Chisholm, Robert B., Jr. "Does God Deceive?" *Bibliotheca Sacra* 155:617 (January-March 1998):11-28.
- \_\_\_\_\_. "The Polemic against Baalism in Israel's Early History and Literature." *Bibliotheca Sacra* 151:603 (July-September 1994):267-83.
- Cohen, Rudolph. "The Fortresses King Solomon Built to Protect His Southern Border." *Biblical Archaeology Review* 11:3 (May-June 1985):56-70.

- \_\_\_\_\_. "Solomon's Negev Defense Line Contained Three Fewer Fortresses." *Biblical Archaeology Review* 12:4 (July-August 1986):40-45.
- Cohen, Shaye J. D. "Solomon and the Daughter of Pharaoh: Intermarriage, Conversion, and the Impurity of Women." *Journal of the Ancient Near Eastern Society* 16-17 (1984-85):23-27.
- Cohn, Robert L. "The Literary Logic of 1 Kings 17—19." *Journal of Biblical Literature* 101:3 (September 1982):333-50.
- \_\_\_\_\_. "Literary Technique in the Jeroboam Narrative." *Zeitschrift für die Alttestamentliche Wissenschaft* 97 (1985):23-35.
- Constable, Thomas L. "1 Kings." In *The Bible Knowledge Commentary: Old Testament*, pp. 483-536. Edited by John F. Walvoord and Roy B. Zuck. Wheaton: Scripture Press Publications, Victor Books, 1985.
- \_\_\_\_\_. *Talking to God: What the Bible Teaches about Prayer*. Grand Rapids: Baker Book House, 1995.
- Craigie, Peter C. *Ugarit and the Old Testament*. Grand Rapids: Wm. B. Eerdmans Publishing Co., 1983.
- Crenshaw, James L. *Old Testament Wisdom: An Introduction*. Atlanta: John Knox, 1981.
- Crockett, William Day. *A Harmony of the Books of Samuel, Kings, and Chronicles*. Grand Rapids: Baker Book House, 1973.
- Cross, Frank M, Jr. *Canaanite Myth and Hebrew Epic*. Cambridge: Harvard University Press, 1973.
- \_\_\_\_\_. "An Interpretation of the Nora Stone." *Bulletin of the American Schools of Oriental Research* 208 (December 1972):13-19.
- Danielius, Eva. "The Sins of Jeroboam Ben-Nebat." *Jewish Quarterly Review* 58:(1967-68):95-114 and 204-23.
- Darby, John Nelson. *Synopsis of the Books of the Bible*. 5 vols. Revised ed. New York: Loizeaux Brothers Publishers, 1942.
- Davis, John J., and John C Whitcomb. *A History of Israel*. Reprint ed., Grand Rapids: Baker Book House, 1980.
- Day, John. "Asherah in the Hebrew Bible and Northwest Semitic Literature." *Journal of Biblical Literature* 105:3 (September 1986):385-408.
- de Vaux, Roland. *Ancient Israel: Its Life and Institutions*. 2 vols. Translated by John McHugh. New York: McGraw-Hill, 1961.
- DeVries, Simon. *1 Kings*. Word Biblical Commentary. Waco: Word Books, 1985.

- Dumbrell, William J. "What Are You Doing Here? Elijah at Horeb." *Crux* 22:1 (March 1986):12-19.
- Dyer, Charles H., and Eugene H. Merrill. *The Old Testament Explorer*. Nashville: Word Publishing, 2001. Reissued as *Nelson's Old Testament Survey*. Nashville: Thomas Nelson Publishers, 2001.
- Edwards, I. E. S. "Egypt: From the Twenty-second to the Twenty-fourth Dynasty." In *Cambridge Ancient History*. 3rd ed. Edited by John Boardman, et al. Cambridge, Eng.: Cambridge University Press, 1982.
- Ellison, H. L. *The Prophets of Israel: From Ahijah to Hosea*. Exeter, Eng.: Paternoster Press, 1969. American ed., Grand Rapids: Wm. B. Eerdmans Publishing Co., 1974.
- Farrar, F. W. *The First Book of Kings*. Reprint ed. Minneapolis: Klock and Klock, 1981.
- Fensham, F. C. "A Few Observations on the Polarisation between Yahweh and Baal in 1 Kings 17—19." *Zeitschrift für die Alttestamentliche Wissenschaft* 92:2 (1980):227-36.
- Finegan, Jack. *Light From the Ancient Past: The Archeological Background of Judaism and Christianity*. 2<sup>nd</sup> ed. Princeton: Princeton University Press; and London: Oxford University Press, 1959.
- Fritz, Volkmar. "Temple Architecture." *Biblical Archaeology Review* 13:4 (July-August 1987):38-49.
- Gaebelein, Arno C. *The Annotated Bible*. 4 vols. Reprint ed. Chicago: Moody Press, and New York: Loizeaux Brothers, Inc., 1970.
- Galil, Gershon. "The Message of the Book of Kings in Relation to Deuteronomy and Jeremiah." *Bibliotheca Sacra* 158:632 (October-December 2001):406-14.
- Gates, John T., and Harold Stigers. "First and Second Kings." In *The Wycliffe Bible Commentary*, pp. 307-66. Edited by Charles F. Pfeiffer and Everett F. Harrison. Chicago: Moody Press, 1962.
- Glickman, Craig. *Solomon's Song of Love*. West Monroe, La.: Howard Publishing Co., 2004.
- Gray, John. *I & II Kings*. Old Testament Library series. London: SCM Press, 1964; revised ed., Philadelphia: Westminster Press, 1970.
- Green, Alberto R. "Israelite Influence at Shishak's Court." *Bulletin of the American Schools of Oriental Research* 233 (1979):59-62.
- Gross, Walter. "Lying Prophet and Disobedient Man of God in 1 Kings 13: Role Analysis as an Instrument of Theological Interpretation of an OT Narrative Text." *Semeia* 15 (1979):97-135.

- Gunn, David M. "David and the Gift of the Kingdom (2 Samuel 2-4, 9-20, 1 Kings 1-2)." *Semeia* 3 (1975):14-45.
- Halpern, Baruch. *The Constitution of the Monarchy in Israel*. Harvard Semitic Monograph 25. Chico, Calif.: Scholars Press, 1981.
- \_\_\_\_\_. "Levitic Participation in the Reform Cult of Jeroboam I." *Journal of Biblical Literature* 95:1 (1976):31-42.
- Hanson, Paul D. "The Song of Heshbon and David's Nir." *Harvard Theological Review* 6 (July 1068):297-320.
- Harrison, Roland K. *Introduction to the Old Testament*. Grand Rapids: Wm. B. Eerdmans Publishing Co., 1969.
- Harton, George M. "Fulfillment of Deuteronomy 28—30 in History and in Eschatology." Th.D. dissertation, Dallas Theological Seminary, 1981.
- Hayman, Leo. "A Note on I Kings 18:27." *Journal of Near Eastern Studies* 10(1951):57-58.
- Heater, Homer, Jr. "A Theology of Samuel and Kings." In *A Biblical Theology of the Old Testament*, pp. 115-55. Edited by Roy B. Zuck. Chicago: Moody Press, 1991.
- Hendricks, Howard G. *Taking A Stand: What God Can Do through Ordinary You*. Portland: Multnomah Press, 1983.
- Herrmann, Siegfried. *A History of Israel in Old Testament Times*. Philadelphia: Fortress Press, 1975.
- Hickman, D. "The Chronology of Israel and Judah." *Catastrophism and Ancient History* 7:2 (July 1985):57-70; 8:1 (January 1986):5-23.
- Hoffmeier, James K. "Egypt As an Arm of Flesh: A Prophetic Response." In *Israel's Apostasy and Restoration: Essays in Honor of Roland K. Harrison*, pp. 79-97. Edited by Avraham Gileadi. Grand Rapids: Baker Book House, 1988.
- House, Paul R. *1, 2 Kings*. New American Commentary series. N.c.: Broadman & Holman Publishers, 1995.
- Howard, David M., Jr. *An Introduction to the Old Testament Historical Books*. Chicago: Moody Press, 1993.
- Hurowitz, V. *I Have Built You an Exalted House: Temple Building in the Bible in Light of Mesopotamian and Northwest Semitic Writing*. *Journal for the Study of the Old Testament Supplement* 115. Sheffield, Eng.: Sheffield Academic Press, 1992.
- Johnson, John E. "The Old Testament Offices as Paradigm for Pastoral Identity." *Bibliotheca Sacra* 152:606 (April-June 1995):182-200.

- Jones, Gwilym H. *1 and 2 Kings*. 2 vols. New Century Bible Commentary series. Grand Rapids: Wm. B. Eerdmans Publishing Co., and London: Marshall, Morgan, and Scott, 1984.
- Josephus, Flavius. *The Works of Flavius Josephus*. Translated by William Whiston. London: T. Nelson and Sons, 1866; reprint ed. Peabody, Mass.: Hendrickson Publishers, 1988.
- Kaufman, Asher S. "Where the Ancient Temple of Jerusalem Stood." *Biblical Archaeology Review* 9:2 (March-April 1983):40-59.
- Keil, C. F. *The Books of the Kings*. Translated by James Martin. Biblical Commentary on the Old Testament. Reprint ed., Grand Rapids: Wm. B. Eerdmans Publishing Co., n.d.
- Kitchen, Kenneth A. *Ancient Orient and Old Testament*. Downers Grove, Ill.: InterVarsity Press, 1966.
- \_\_\_\_\_. *The Bible In the World*. Downers Grove, Ill.: InterVarsity Press, 1977.
- \_\_\_\_\_. "How We Know When Solomon Ruled." *Biblical Archaeology Review* 27:5 (September/October 2001):32-37, 58.
- \_\_\_\_\_. "The Old Testament in its Context: 4 The Twin Kingdom, Judah and Assyria (c. 930-640 BC)." *Theological Students' Fellowship Bulletin* 62 (1972):2-10.
- Klein, Ralph W. "Jeroboam's Rise to Power." *Journal of Biblical Literature* 89:2 (June 1970):217-18.
- \_\_\_\_\_. "Once More: 'Jeroboam's Rise to Power.'" *Journal of Biblical Literature* 92:4(December 1973):582-84.
- Krummacker, F. W. *Elijah the Tishbite*. Reprint ed. Grand Rapids: Zondervan Publishing House, n.d.
- Lange, John Peter, ed. *Commentary on the Holy Scriptures*. 12 vols. Reprint ed., Grand Rapids: Zondervan Publishing House, 1960. Vol. 3: *Samuel-Kings*, by Chr. Fr. David Erdmann and Karl Chr. W. T. Bahr. Translated, enlarged, and edited by C. H. Toy, John A. Broadus, Edwin Harwood, and W. G. Sumner.
- Liver, J. "The Books of the Acts of Solomon." *Biblica* 48:1(1967):75-101.
- Long, Burke O. "A Darkness Between Brothers: Solomon and Adonijah." *Journal for the Study of the Old Testament* 19 (February 1981):79-94.
- Longman, Tremper, III and Raymond B. Dillard. *An Introduction to the Old Testament*. 2<sup>nd</sup> ed. Grand Rapids: Zondervan, 2006.
- Luckenbill, D. D. "Benhadad and Hadadezer." *American Journal of Semitic Languages* 27(1911):267-84.

- Lundquist, John M. "Temple, Covenant, and Law in the Ancient Near East and in the Old Testament." In *Israel's Apostasy and Restoration: Essays in Honor of Roland K. Harrison*, pp. 293-305. Edited by Avraham Gileadi. Grand Rapids: Baker Book House, 1988.
- Lust, J. "A Gentle Breeze or a Roaring Thunderous Sound?" *Vetus Testamentum* 25:1(January 1975):110-15.
- Maller, Allen S. "Hiram from Tyre." *Journal or Reform Judaism* 29:2(Spring 1982):41-42.
- Mayhue, Richard L. "False Prophets and the Deceiving Spirit." *Master's Seminary Journal* 4:2 (Fall 1993):135-63.
- Mazar, Benjamin. "The Campaign of Pharaoh Shishak to Palestine." *Vetus Testamentum Supplements* 4 (1957):57-66.
- McFall, Leslie. "A Translation Guide to the Chronological Data in Kings and Chronicles." *Bibliotheca Sacra* 148:589 (January-March 1991):3-45.
- McNeely, Richard I. *First and Second Kings*. Everyman's Bible Commentary series. Chicago: Moody Press, 1979.
- McNicol, Allan J. "The Heavenly Sanctuary in Judaism: A Model for Tracing the Origin of an Apocalypse." *Journal of Religious Studies* 13:2 (1987):66-94.
- Merrill, Eugene H. "The Veracity of the Word: A Summary of Major Archaeological Finds." *Kindred Spirit* 34:3 (Winter 2010):13.
- Meyer, F. B. *Elijah and the Secret of His Power*. Chicago: Fleming H. Revell, n.d.
- Mitchell, T. C. "Israel and Judah Until the Revolt of Jehu (931-841 B.C.)." In *Cambridge Ancient History*. 3rd ed. Edited by John Boardman, et al. Cambridge, Eng.: Cambridge University Press, 1982.
- Miller, J. Max. "So Tibni Died." *Vetus Testamentum* 18(1968):392-94.
- Monson, James M. *The Land Between*. Jerusalem: By the author, P.O. Box 1276, 1983.
- Montgomery, James A. "Archival Data in the Books of Kings." *Journal of Biblical Literature* 53(1934):46-52.
- \_\_\_\_\_. *A Critical and Exegetical Commentary on the Books of Kings*. International Critical Commentary series. Edited by Henry Snyder Gehman. Edinburgh: T. and T. Clark, 1967.
- Morgan, G. Campbell. *Living Messages of the Books of the Bible*. 2 vols. New York: Fleming H. Revell Co., 1912.
- Morgenstern, Julian. "Chronological Data of the Dynasty of Omri." *Journal of Biblical Literature* 59(1940):385-96.



- Myers, Jacob. *II Chronicles*. Anchor Bible series. Garden City, N.Y.: Doubleday, 1965.
- Napier, B. D. "The Omrides of Jezreel." *Vetus Testamentum* 9 (1959):366-78.
- Nelson, R. D. *First and Second Kings*. Interpretation: A Biblical Commentary for Preaching and Teaching series. Louisville: John Knox, 1987.
- The Nelson Study Bible*. Edited by Earl D. Radmacher. Nashville: Thomas Nelson Publishers, 1997.
- The NET (New English Translation) Bible*. First beta printing. Spokane, Wash.: Biblical Studies Press, 2001.
- Newsome, James D., Jr. ed. *A Synoptic Harmony of Samuel, Kings, and Chronicles*. Grand Rapids: Baker Book House, 1986.
- Noth, Martin. *The Deuteronomistic History*. Journal for the Study of the Old Testament Supplement Series, 15. Sheffield, Eng.: JSOT Press, 1981.
- Oppenheim, A. Leo. *Ancient Mesopotamia*. Chicago: University of Chicago Press, 1964.
- Oswalt, John N. "The Golden Calves and the Egyptian Concept of Deity." *Evangelical Quarterly* 45 (1973):13-20.
- Ovellette, Jean. "The Solomonic *Debir* according to the Hebrew Text of I Kings 6." *Journal of Biblical Literature* 89:3 (September 1970):338-43.
- Parker, Kim Ian. "Repetition as a Structuring Device in 1 Kings 1—11." *Journal for the Study of the Old Testament* 42 (October 1988):19-27.
- Patterson, Richard D. "The Widow, the Orphan, and the Poor in the Old Testament and the Extra-Biblical Literature." *Bibliotheca Sacra* 130:519 (July-September 1973):223-34.
- Patterson, Richard D., and Hermann J Austel. "1, 2 Kings." In *1 Kings—Job*. Vol. 4 of *The Expositor's Bible Commentary*. 12 vols. Edited by Frank E. Gaebelien and Richard P. Polcyn. Grand Rapids: Zondervan Publishing House, 1988.
- Payne, J. Barton. "Second Chronicles." In *The Wycliffe Bible Commentary*, pp. 391-421. Edited by Charles F. Pfeiffer and Everett F. Harrison. Chicago: Moody Press, 1962.
- \_\_\_\_\_. *The Theology of the Older Testament*. Grand Rapids: Zondervan Publishing House, 1962.
- Peterson, Eugene H. *The Message: The Bible in Contemporary Language*. 2002. Version 2. Numbered ed. Colorado Springs: NavPress, 2005.
- Pfeiffer, Charles F., and Howard F. Vos. *The Wycliffe Historical Geography of Bible Lands*. Chicago: Moody Press, 1967.

- Porten, Bezalel. "The Structure and Theme of the Solomon Narrative (1 Kings 3-11)." *Hebrew Union College Annual* 38 (1967):93-128.
- Pritchard, James B., ed. *Ancient Near Eastern Texts Relating to the Old Testament*. 2nd ed. Princeton: Princeton University Press, 1955.
- Rasmussen, Carl G. "The Economic Importance of Caravan Trade for the Solomonic Empire." In *A Tribute to Gleason Archer*, pp. 153-66. Edited by Walter C. Kaiser Jr. and Ronald F. Youngblood. Chicago: Moody Press, 1986.
- Rendsburg, Gary A. "The Mock of Baal in 1 Kings 18:27." *Catholic Biblical Quarterly* 50:3 (July 1988):414-17.
- Rice, Gene. *Nations under God*. International Theological Commentary series. Grand Rapids: Wm. B. Eerdmans Publishing Co., and Edinburgh: The Handsel Press Ltd., 1990.
- Ringgren, Helmer. *Religions of the Ancient Near East*. Philadelphia: Westminster Press, 1973.
- Rofe, Alexander. "The Vineyard of Naboth: The Origin and Message of the Story." *Vetus Testamentum* 38:1 (1988):89-104.
- Rogers, Jeffrey S. "Narrative Stock and Deuteronomistic Elaboration in 1 Kings 2." *Catholic Biblical Quarterly* 50:3 (July 1988):398-413.
- Rowley, H. H. "Elijah on Mount Carmel." *Bulletin of the Johns Rylands Library* 43:1 (September 1960):190-219.
- Ruth, Richard L. "The Doctrine of Dreams." *Bibliotheca Sacra* 124:500 (October-December 1968):360-64.
- Ruthven, Jon. "A Note on Elijah's 'Fire from Yahweh.'" *Journal of the Evangelical Theological Society* 12:2 (1969):111-15.
- Saint-Laurent, George. "Light from Ras Shamra on Elijah's Ordeal upon Mount Carmel." In *Scripture in Context*, pp. 123-39. Edited by Carl D. Evans, et al. Pittsburgh: Pickwick, 1980.
- Savran, George. "1 and 2 Kings." In *The Literary Guide to the Bible*, pp. 146-64. Edited by Robert Alter and Frank Kermode. Cambridge: Harvard University Press, 1987.
- Schulman, Alan R. "Diplomatic Marriage in the Egyptian New Kingdom." *Journal of Near Eastern Studies* 38 (1979):177-193.
- Schwantes, Siegfried J. *A Short History of the Ancient Near East*. Grand Rapids: Baker Book House, 1965.
- Selms, A. Van. "The Origin of the Title 'The King's Friend.'" *Journal of Near Eastern Studies* 16 (1957):118-23.

- Shanks, Hershel. *The City of David*. Washington: The Biblical Archaeology Society, 1973.
- Shea, William H. "A Note on the Date of the Battle of Qarqar." *Journal of Cuneiform Studies* 29 (1977):240-42.
- Simon, Uriel. "I Kings 13: A Prophetic Sign—Denial and Persistence." *Hebrew Union College Annual* 47 (1976):81-117.
- Slotki, I. W. *Kings*. London: Soncino Press, 1950.
- Smith, James E. "Prolegomena to the Study of Kings." *Seminary Review* 21:3 (September 1975):77-115.
- Soards, Marion L., Jr. "Elijah and the Lord's Word: A Study of I Kings 17:17-24." *Studia Biblica et Theologica* 13:1 (April 1983):39-50.
- Soggin, J. Alberto. "Compulsory Labor Under David and Solomon." In *Studies in the Period of David and Solomon and Other Essays*, pp. 259-67. Edited by Tomoo Ishida. Winona Lake, Ind.: Eisenbrauns, 1983.
- Smith, J. M. P. "The Character of King David." *Journal of Biblical Literature* 52 (1933):1-11.
- Smith, Morton. "The So-Called 'Biography of David' in the Books of Samuel and Kings." *Harvard Theological Review* 44 (1951):167-69.
- Storms, C. Samuel. *Reaching God's Ear*. Wheaton: Tyndale House, 1988.
- Stuart, Douglas K. "David's 'Lamp' (1 Kings 11:36) and 'a Still Small Voice' (1 Kings 19:12)." *Bibliotheca Sacra* 171:681 (January-March 2014):3-18.
- Student Map Manual*. Jerusalem: Pictorial Archive (Near Eastern History) Est., 1979.
- Thiele, Edwin R. *A Chronology of the Hebrew Kings*. Contemporary Evangelical Perspectives series. Grand Rapids: Zondervan Publishing House, 1981.
- \_\_\_\_\_. "Coregencies and Overlapping Reigns Among the Hebrew Kings." *Journal of Biblical Literature* 93 (1974):174-200.
- \_\_\_\_\_. *The Mysterious Numbers of the Hebrew Kings*. Grand Rapids: Wm. B. Eerdmans Publishing Co., 1965.
- Thomsom, H. C. "A Row of Cedar Beams." *Palestinian Exploration Quarterly* 92 (1960):57-63.
- "Tirzah: An Early Capital of Israel." *Buried History* 22:1 (March 1986):14-24.
- Torcszyner, Harry. "The Riddle in the Bible." *Hebrew Union College Annual* 1 (1924):125-49.
- Tromp, Nicholas J. "Water and Fire on Mount Carmel." *Biblica* 56:4 (1975):480-502.

- Ullendorff, Edward. "The Queen of Sheba." *Bulletin of the John Rylands Library* 45:2 (1963):486-504.
- Unger, Merrill F. *Israel and the Aramaeans of Damascus*. Reprint ed. Grand Rapids: Baker Book House, 1980.
- Ussishkin, David. "King Solomon's Palaces." *Biblical Archaeologist* 36 (1973):78-105.
- Van Beek, Gus W. "Frankincense and Myrrh." *Biblical Archaeologist* 23:3 (September 1960):70-95.
- Von Wyrick, Stephen. "Israel's Golden Calves." *Biblical Illustrator* 13:1 (Fall 1986):3, 9-12.
- Wallace, N. H. "The Oracles Against the Israelite Dynasties in 1 and 2 Kings." *Biblica* 67:1 (1986):21-40.
- Weinfeld, Moshe. "The Counsel of the 'Elders' to Rehoboam and Its Implications." *MAARAV* 3:1 (January 1982):27-53.
- Whitelam, Keith W. "The Defence of David." *Journal for the Study of the Old Testament* 29 (June 1984):61-87.
- \_\_\_\_\_. "The Symbols of Power." *Biblical Archaeologist* 49:3 (September 1986):166-73.
- Williamson, H. G. M. *1 and 2 Chronicles*. New Century Bible Commentary series. Grand Rapids: Wm. B. Eerdmans Publishing Co., 1982.
- Wiseman, Donald John. *1 & 2 Kings: An Introduction and Commentary*. Tyndale Old Testament Commentaries series. Downers Grove, Ill., and Leicester, Eng.: InterVarsity Press, 1993.
- Wood, Leon J. *Elijah, Prophet of God*. Des Plaines, Ill.: Regular Baptist Press, 1968.
- \_\_\_\_\_. *Israel's United Monarchy*. Grand Rapids: Baker Book House, 1979.
- \_\_\_\_\_. *The Prophets of Israel*. Grand Rapids: Baker Book House, 1979.
- \_\_\_\_\_. *A Survey of Israel's History*. Grand Rapids: Zondervan Publishing House, 1970.
- The Wycliffe Bible Encyclopedia*. 1975 ed. S.v. "Moab, Moabite," by Arnold C. Schultz.
- Young, Rodger C. "When Did Solomon Die?" *Journal of the Evangelical Theological Society* 46:4 (December 2003):589-603.
- Zevit, Ziony. "Deuteronomistic Historiography in 1 Kings 12—2 Kings 17 and the Reinvestiture of the Israelian Cult." *Journal for the Study of the Old Testament* 32 (1985):57-73.
- Zuidhof, Albert. "King Solomon's Molten Sea and (pi)." *Biblical Archaeologist* 45:3 (Summer 1982):179-84.